

**SHAREATE**

QUALITY WINS RESPECT



**ROCK DRILL TOOLS**  
**TRI-CONE DRILL BIT**



**SHAREATE**  
**SHAREATE TOOLS LTD.**

Add: No.6 Weixi Road, Industrial Park,Suzhou,Jiangsu. 215121,China.

Tel: +86 512 62851657 Fax: +86 512 62851661

\* The contents of this brochure may not be reproduced or reproduced without permission.

**SHAREATE TOOLS LTD.**

# Table of Contents

- 01 Product Overview**
  - 1.1 Basic Structure of Mining Drill Bit
  - 1.2 Product Characteristics
- 02 Tri-cone Bits Selection Chart**
  - 2.1 Naming of Drill Bit Series
  - 2.2 Drill Bit Selection Chart
  - 2.3 Nozzle Selection Chart
  - 2.4 Drill Pipe Connection Thread Selection Chart
- 03 Operating instructions**
  - 3.1 Drill Bit Requirements
  - 3.2 Drill Bit Size, Thread Connection and Recommended Make-up Torque
  - 3.3 Drilling Parameter Selection Chart (Weight on Bit and Rotary Speed)
  - 3.4 Bit failure types and product selection



# 01 Product Overview

SHAREATE TOOLS LTD. mining tri-cone drill bit is mainly used in large open-pit mining operations, such as open-pit coal mines, copper mines, molybdenum mines, iron ore mines and other non-ferrous metal mines. Tri-cone drill bits are used on rotary drills, with a proven reputation of high performance and low cost. Shareate has large scale drill bit R&D and manufacturing facilities in China using world class, leading technologies.

The company has adopted a flexible production system with the incorporation of CNC machining centres, being its core component. The production line consists of manufacturing equipment such as forging, heat-treatment, CNC machining centres, along with advanced inspection equipment.

Our products are designed and manufactured to our certified API Q1 specification and ISO 9001 standards. The tri-cone drill bits range from 6 1/4" to 13 3/4" in size, and the production line is capable of customised design to manufacture for different sizes and series of drill bits to meet our customer's requirements.

## 1.1 Basic Structure of Mining Drill Bit

Tri-cone drill bits consists of a bearing structure, cutting structure, shirttail and lug enhancement structures, flow channel system, and a thread connections.

The bearing structure consists of lug bearing, cone bearing, seal ring (sealed bearing), main rollers, minor rollers, locking bearing balls, axle thrust plate, and recess thrust plate. They are categorised into air cooled open bearing or sealed bearing.

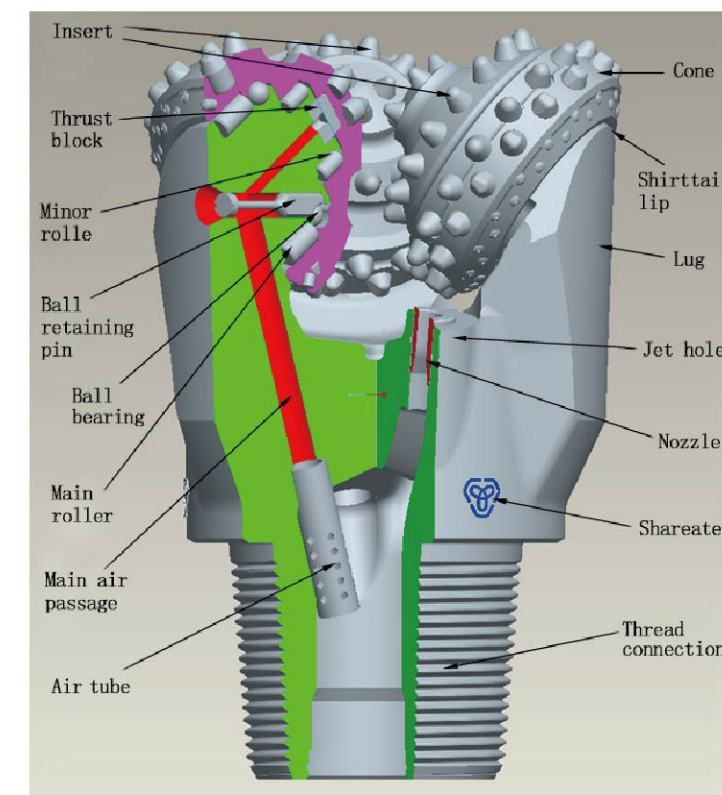

## 1.2 Product Characteristics

### >> Cutting Structure

- Specific insert type and material grade are selected based on ground formation strength and friability to optimize matching of carbide through its wear resistance and toughness.
- Computer simulated bottom hole impact curve design helps to arrange inserts effectively, and balance the working load of drill bit inserts.
- Double bevel inserts: two rows of cross patterned bevel inserts are designed to strengthen the gaging performance.

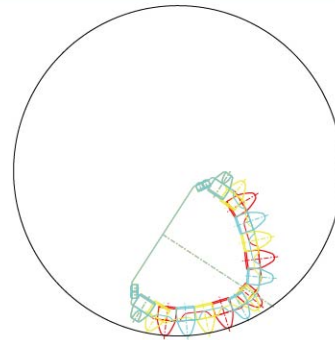

Bottom hole impact curve design

### >> Bearing structure

By calculating the load distribution of each component in the bearing, the bearing geometric structure is designed to distribute bearing load evenly, which enhances the working life.

#### • Open bearing

Bearing structure: main roller – ball bearing - minor roller - thrust block, open bearing structure without seal ring

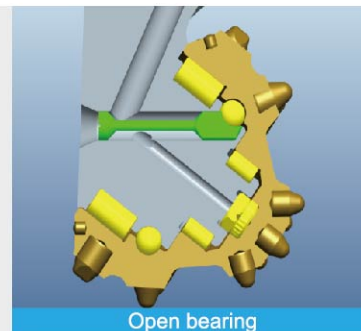

Open bearing

#### • Sealed Bearing

Bearing structure: O-Ring Seal--main roller – ball bearing - minor roller - thrust block, sealed bearing

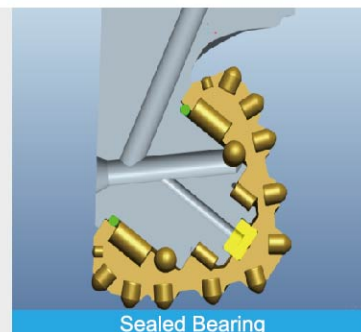

Sealed Bearing

#### • Composite Sealed Bearing

Bearing structure: Composite seal ring - main roller - ball bearing - minor roller - thrust block, sealed bearing

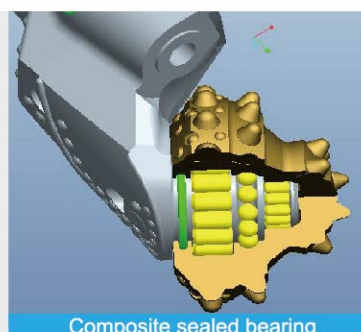

Composite sealed bearing

### >> Lug Back Protection

Lug back design promotes lift force which increases bailing space, accelerates bailing velocity and reduces wear on drill bit from cutting regrinds.



Lug back

### >> Tri-cone Drill Bit Structural Feature Chart

Bit Structural Characteristics	SG	SGA	SGV
Open bearing	•		
Sealed bearing		•	•
O-ring seal		•	
Rubber flat seal			•

### >> Shareate Bit Identification

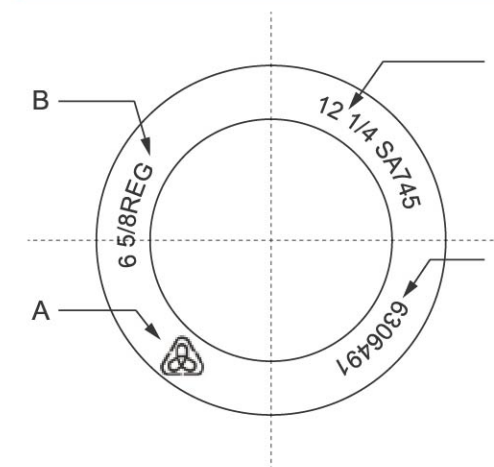

	A	B	C	D
		6 5/8 REG	12 1/4 SA745	6306491
A	Shareate Brand			
B	Thread Connection		6 5/8 REG	
C	Bit Diameter & Type		12 1/4 SA745	
D	Bit Serial Number		6306491	

## 02 Tri-cone Bits Selection Chart

### 2.1 Naming of Drill Bit Series

Shareate drill bit product model is divided into four sections: drill bit diameter code, drill bit series code, drill bit category code, and additional features code. Using 12 1/4 format to be consistent with others SG745GF as an example:

12 1/4	SGA	745	GF
Drill bit size	Drill bit series	Drill bit category	Additional features

- The first part is categorised based on drill hole operation requirement for selecting the correct bit size, displayed in numbers (integer or fraction) to indicate the diameter in inches. Our current tri-cone product range includes 6 1/4, 6 3/4, 7 7/8, 8 1/2, 9, 9 7/8, 10 5/8, 11, 12 1/4, and 13 3/4 (inch).
- The second part is based on drilling operating requirements for selecting the correct drill bit bearing and sealing structure, which is divided into the following series:
  - SG series: Air cooled open bearing structure;
  - SA, SGA series: Sealed bearing structure;
  - SGV series: Composite sealed bearing structure.
  - TJ series: Water circulation cooled pilot hole drill bit series for use with raise boring rig.
- The third part adapts the SPE/IADC codes, consisting of three digits, with the first digit of the IADC code referencing the cutting structure and formation series, the second digit further categorises the formation classification and the last digit is the drill bit structure characteristic code.
  - The first digit ranges from 4 to 8, which designates soft formation, medium-soft formation, medium-hard formation, hard formation and extremely hard formation.
  - The second digit classification ranges from 1 to 4, further categorising the formation. 1 being the softest formation, and 4 being the hardest formation.
  - The third digit classifies the structural characteristics of the drill bit which is divided into air-cooled bearings and sealed bearings, expressed by 2 and 5 respectively.

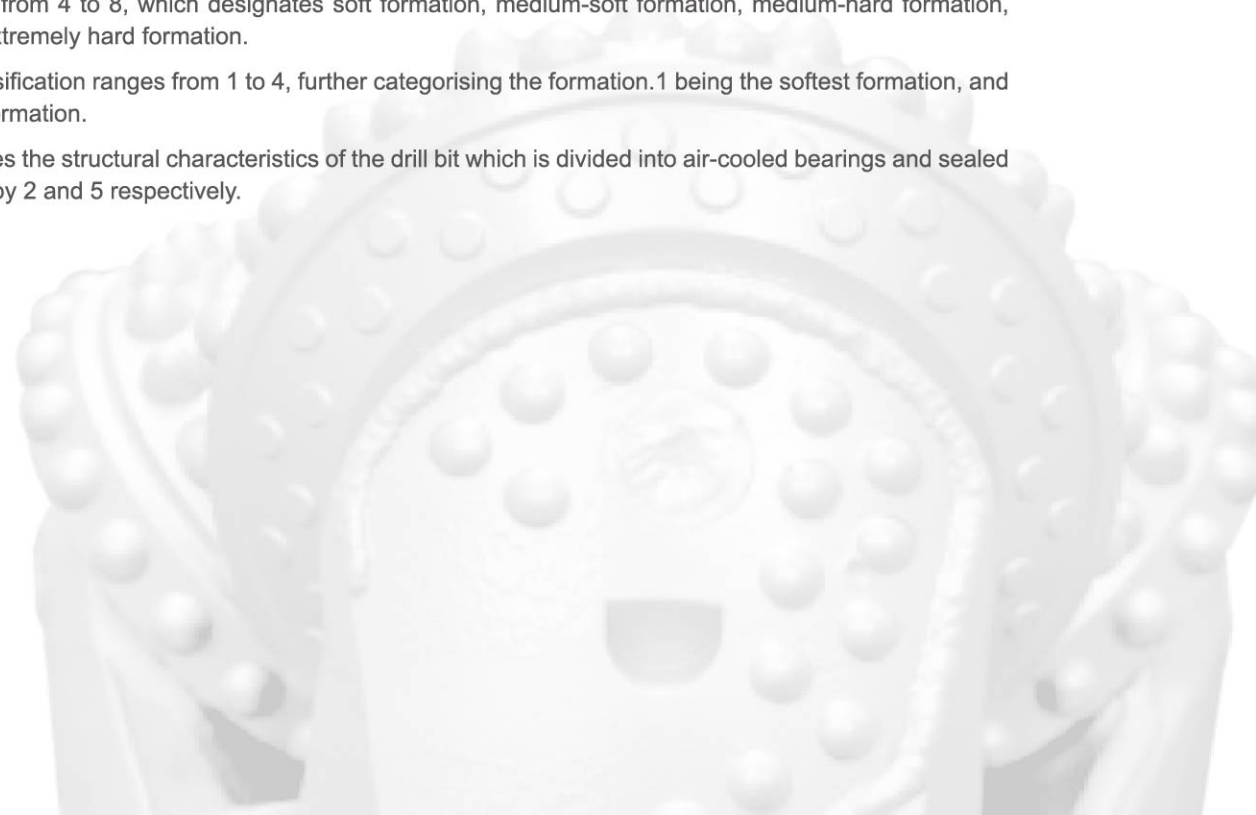

- The fourth part affirms additional features. Shareate tri-cone drill bits can be manufactured with the following additional features:

#### >> G feature: Specific lug back strengthening



New Enhanced Lug Back



Conventional Lug Back

The new enhanced lug back with additional carbide effectively reduces the wear in abrasive ground conditions, improving the gage performance and bit life. In addition to the previous lug back protection inserts, more carbide have been added onto the chamfer, which is located just above oil storage port. This feature helps to prolong bit life by reducing the back reaming wear on the lug area especially in the scenario of a collapsed hole.

#### >> F feature: Cone auxiliary carbide protection

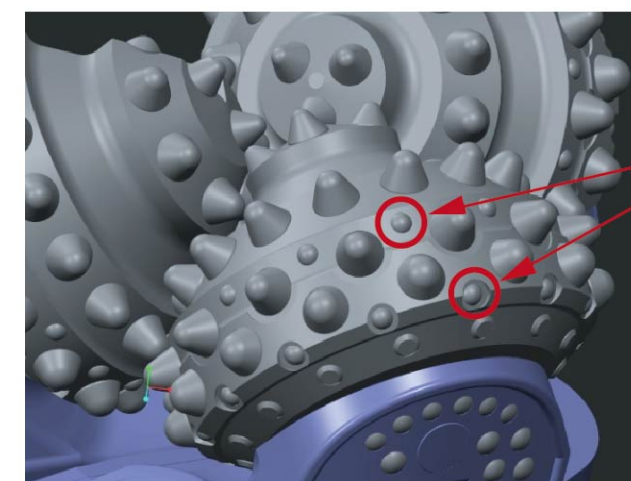

Auxiliary carbide

Auxiliary carbides are embedded in between the main cutting rows and outer rows on each cones, effectively protecting the cone body from erosion and enhancing drill bit life in abrasive formations.

**>> C feature: Centre nozzle port**

---

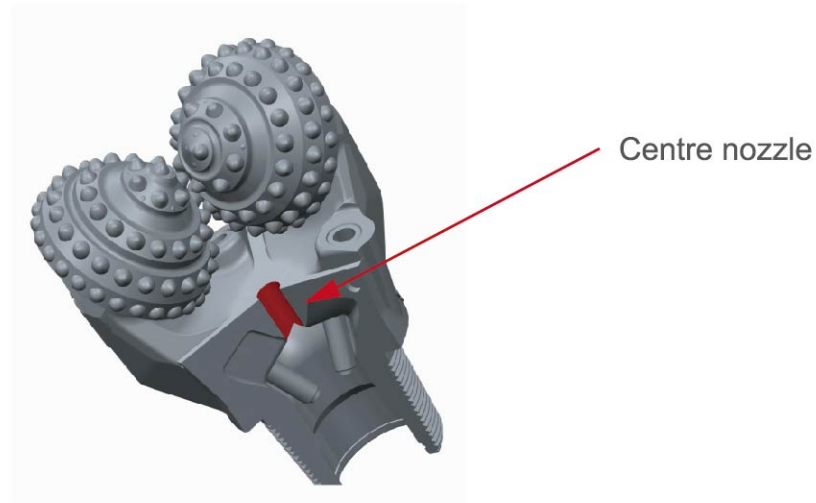

The centre nozzle port helps to clean the cuttings around the bottom of the drill bit, accelerates the bailing of cuttings, reducing the cone edge wear and increases the drill bit penetration rate.

**>> R feature: Shirttail hardfacing(W feature)and lug back strengthening(G feature)**

---

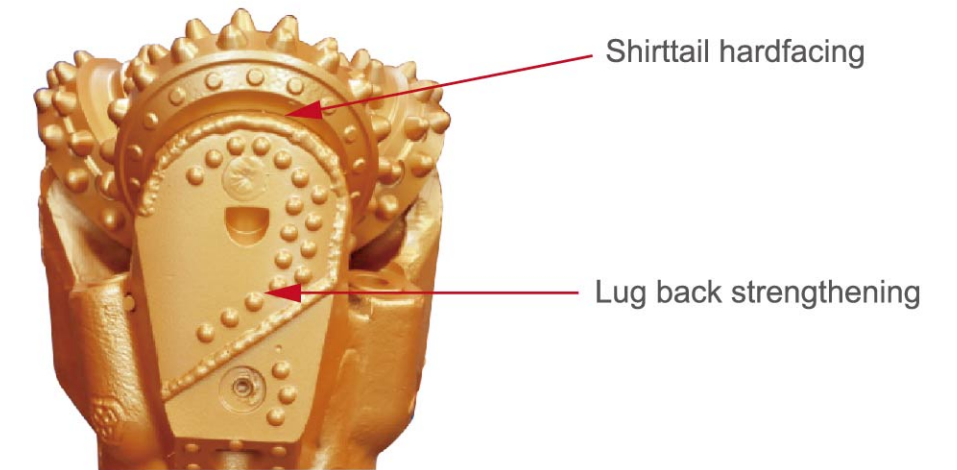

Shirttail hardfacing (W feature) and lug back strengthening (G feature) can effectively reduce wear on lug while improving the drill bit gage performance and bit life.

**>> W feature: Shirttail hardfacing**

---



WC (tungsten carbide) wear-resistant material is welded on the lug shirttail, which effectively reduces wear, protects the sealing structure, and prolongs the life of the bit.

**>> B feature: Cone groove/bevel hardfacing**

---



WC (tungsten carbide) wear-resistant material is welded on the cone groove or bevel to protect cone body against wear and enhancing bit life in abrasive formations.

## 2.2 Drill Bit Selection Chart

(selection based on rock characteristics, compressive strength, friability, etc.)

### Shareate Mining Tri-cone Drill Bit Series and Applicable Rock Compressive Strength Chart

Drill Bit Series	Rock Compressive Strength (Psi)	Rock Compressive Strength (MPa)
412/415	4000—7000	27—48
422/425	5000—8000	34—55
432/435	6000—9000	41—62
442/445	7000—10000	48—69
512/515	9000—15000	62—103
522/525	12000—19000	83—131
532/535	15000—23000	103—159
542/545	18000—27000	124—186
612/615	23000—30000	159—207
622/625	26000—34000	179—234
632/635	29000—38000	200—262
642/645	32000—42000	221—290
712/715	37000—44000	255—303
722/725	40000—48000	276—331
732/735	43000—52000	296—359
742/745	46000—56000	317—386
812/815	49000—58000	338—400
822/825	52000—62000	359—427
832/835	55000—66000	379—455
842/845	58000—70000	400—483

## 2.3 Nozzle Selection Chart

Nozzle Size		Bit Size										
		mm	152	171	200	216	229	251	270	279	311	349
		inch	6 1/4	6 3/4	7 7/8	8 1/2	9	9 7/8	10 5/8	11	12 1/4	13 3/4
mm	inch											
8	0.315		•	•	•	•	•	•				
9	0.354		•	•	•	•	•	•				
10	0.394		•	•	•	•	•	•				
11	0.433		•	•	•	•	•	•	•	•	•	•
12	0.472		•	•	•	•	•	•	•	•	•	•
13	0.512		•	•	•	•	•	•	•	•	•	•
14	0.551		•	•	•	•	•	•	•	•	•	•
15	0.591		•	•	•	•	•	•	•	•	•	•
16	0.630		•	•	•	•	•	•	•	•	•	•
17	0.669		•	•	•	•	•	•	•	•	•	•
18	0.709		•	•	•	•	•	•	•	•	•	•
19	0.748		•	•	•	•	•	•	•	•	•	•
20	0.787		•	•	•	•	•	•	•	•	•	•
21	0.827					•	•	•	•	•	•	•
22	0.866					•	•	•	•	•	•	•
23	0.906					•	•	•	•	•	•	•
24	0.945					•	•	•	•	•	•	•
25	0.984					•	•	•	•	•	•	•
26	1.024							•	•	•	•	•
27	1.063							•	•	•	•	•
28	1.102							•	•	•	•	•

## 2.4 Drill Pipe Connection Thread Selection Chart

Bit Diameter	mm	152	171	200	216	229	251	270	279	311	349
	inch	6 1/4	6 3/4	7 7/8	8 1/2	9	9 7/8	10 5/8	11	12 1/4	13 3/4
API(REG)		3 1/2	3 1/2	4 1/2	4 1/2	4 1/2	6 5/8	6 5/8	6 5/8	6 5/8	6 5/8
BECO				4 1/2	4 1/2	4 1/2	6	6	6	6	6

☆ Note: We can design and manufacture to custom sizes and connection thread specifications according to the customer's requirements.

## 03 Operating Instructions

Tri-cone drill bits are mainly used in large open-pit mining operations for blast hole drilling. Due to the harsh mining environment and complex formation changes, the bit must be correctly used in order to improve bit service life and increase cost-effectiveness.

### 3.1 Drill Bit Requirements

- Do not soak new drill bit in thin oil or solvent, as this will cause seal ring failure and loss of lubricant.
- Before replacing a new bit, check in detail whether the rotation of the three cones is flexible; also, check if the thread connection and inserts are in good condition.
- The drill rod stabilizer shall be replaced regularly to ensure it has sufficient outside diameter to stabilise the drill pipe and protect the drill bit.
- It is not advised to use bent drill pipe to avoid uneven force on the three cones which will accelerate damage to the drill bit.
- When working in different formations, the drill bits series should be selected accordingly.
- During the running-in process of new bits, the pull down and rotation speed need be lower, which means 1/3 for first hole, 2/3 for second hole, 3/3 for the subsequent holes.
- When starting a new hole with a new bit, remove any foreign objects around the area (such as bulk rock or metal objects), start the hole with air, slow rotation, and slow feed, to avoid damaging the bit from impact.
- When drill bit is being replaced in the middle of the operation in soft formation, cones and inserts of the dead drill bit should be checked to see whether any foreign material has been left at the bottom of the hole. If there are remnants of the dead bit in the hole, it is not advised to use the new bit to redrill the same hole. Doing so may immediately fail the new bit.
- If a bit is replaced because it is not suitable for current ground conditions, the bit can be reused in softer areas to maximise the economic benefit of the bit.
- When drilling operations cease, it is important to clean the bit in a timely manner. The bit should not be left in the hole, especially if the hole contains water. This prevents the backflow of rock cuttings or water getting into the bearing and damaging the bit.
- It is necessary to use bits with back flow valves when working in conditions which contain water, and increase the air pressure appropriately to prevent backflow of cuttings or water.
- Tri-cone drill bits must be used within the recommended operating parameters; air pressure, axial pressure and rotation speed. These factors should be checked regularly and adjusted to suit drilling conditions.
- When drilling through fragmented rock, cavities, or if the hole collapses, the axial pressure and rotational speed should be reduced to prevent inserts from breaking.
- When the drill tool is in the hole, it is strictly forbidden to engage reverse rotation to prevent the bit from unscrewing.
- When the air is turned off, it is possible for rock cuttings to enter the bearing; rotation without air clearing the cutting will result in accelerated bit wear and bearing wear. Therefore, rotation should cease when the air is turned off.

- Monitor the air circuit for leakage during drilling operation regularly to ensure there is no leakage or significant loss of pressure. The air volume and pressure are important for clearing the cuttings, which can affect the bit life.
- Regularly check the concentricity or run out of the drill pipe. If eccentricity occurs, it must be replaced or repaired immediately.
- Always record meters drilled, time in the hole, RPM, WOB (weight on bit), air pressure (psi), formation drilled and any unusual drilling conditions.

### 3.2 Drill Bit Size, Thread Connection and Recommended

#### Make-up Torque

Bit Size		API REG Thread	Make-up Torque
Inch	Millimetre	Inch	kN/m
6 1/4	158.8	3 1/2	9.5~12.2
6 3/4	171.5	3 1/2	9.5~12.2
7 7/8	200.0	4 1/2	16.3~21.7
8 1/2	215.9	4 1/2	16.3~21.7
9	228.6	4 1/2	16.3~21.7
9 7/8	250.8	6 5/8	38~43.4
10 5/8	269.9	6 5/8	38~43.4
11	279.4	6 5/8	38~43.4
12 1/4	311.2	6 5/8	38~43.4
13 3/4	349.3	6 5/8	38~43.4

### 3.3 Drilling Parameter Selection Chart









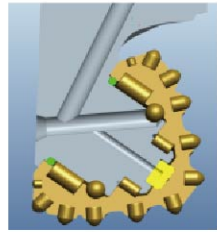

(Weight on Bit and Rotary Speed)

IADC	Weight on Bit per Inch of Bit Diameter (lb/in)	Rotary Speed (r/min)	Cutting Structure	Applications
412 415	1000—2000	90—120	Conical on gage and inner rows	Designed for very soft formations with low compressive strength and high friability such as shale, soft limestone, sandstone, gravel clay, soft dolomite, coal.
432 435	1000—4000	90—120	Conical/Chisel on gage, Conical inner rows	Designed for very soft formations with low compressive strength and high friability such as shale, soft limestone, sandstone, gravel clay, soft dolomite, coal.
532 535	2000—5000	80—110	Conical/Chisel on gage, Conical inner rows	Designed for soft formations with low compressive strength, such as shale, soft limestone, interbedded dolomite, coal.
612 615	3000—5000	60—100	Conical/Spherical on gage, Conical inner rows	Designed for high compressive strength, medium hard and abrasive formations, such as limestone, sandstone, interbedded dolomite.
632 635	3000—6000	60—100	Conical/Spherical on gage, Conical inner rows	Designed for high compressive strength, medium hard and abrasive formations, such as limestone, sandstone, interbedded dolomite.
732 735	4000—7000	60—90	Spherical on gage, Conical/Double spherical on inner rows	Designed for high compressive strength, hard and abrasive formations, such as granite, limestone, sandstone, dolomite.
832 835	5000—8000	50—80	Spherical on gage, Double spherical on inner rows	Designed for high compressive strength, hard and abrasive formations, such as magnetite quartzite, quartzite, granite.

☆ Note: Maximum weight on bit and rotation speeds should not be both applied at the same time.

### 3.4 Bit failure types and product selection

The common failure types for tri-cone bits are bearing failure, cutting structure failure, and cone body wear.

Failure types	Failure image	Recommendation	Image
Bearing failure		Recommend sealed bearing	
Broken Insert (Cutting rows)		Select a bit suitable for harder formation	
Broken Insert (Gage rows)		Choose the feature F for drilling in soft formation to reduce cone body wear	
Broken Insert (Coring)		Choose the feature F for drilling in hard formation to reduce cone body wear	
Shirttail and lug back wear		Choose the feature R for strengthened shirttail and lug back protection	
Wear on the top of lug back		Choose the feature R with protection on the top of lug back	



## 6 1/4 SG412

### CUTTING STRUCTURE

Chisel on gage, conical on inner rows.

Designed for very soft formations with low compressive strength and high friability such as shale, soft limestone, sandstone, gravel clay, soft dolomite, coal ore.

Compressive strength: 4,000–7,000 psi/27–48 MPa

### SHIRTTAIL PROTECTION

Hard welding and wear resistant carbide protection on shirrtail lip and lug

### PRODUCT SPECIFICATION

IADC Code: 412  
 Bearing Type: Roller-Ball-Roller-Thrust Button/Open Bearing  
 Circulation Type: Jet Air  
 Cutting Structure:  
 Inner and Nose Rows: Conical  
 Gage Rows: Chisel  
 Auxiliary Carbide: Spherical  
 Pin Connection: 3 1/2" API REG  
 Metric Bit Diameter: 159 mm  
 Product Weight: 44 lbs/20 kg

### OPERATING SUGGESTIONS

Weight on Bit: 6,250–12,500 lbs/ 2.8–5.7 T  
 Rotational Speed: 90–120 rpm  
 Air Back Pressure: 29–58 psi/0.2–0.4 MPa



## 6 1/4 SG632

### CUTTING STRUCTURE

Spherical on gage, double spherical on inner rows.

Designed for high compressive strength, medium hard and abrasive formations, such as limestone, sandstone, interbedded dolomite.

Compressive strength: 29,000–38,000 psi/200–262 MPa

### SHIRTTAIL PROTECTION

Hard welding and wear resistant carbide protection on shirrtail lip and lug

### PRODUCT SPECIFICATION

IADC Code: 632  
 Bearing Type: Roller-Ball-Roller-Thrust Button/Openair Bearing  
 Circulation Type: Jet Air  
 Cutting Structure:  
 Inner and Nose Rows: Double spherical  
 Gage Rows: Spherical  
 Gage Bevel Protection: Ovoid  
 Pin Connection: 3 1/2" API REG  
 Metric Bit Diameter: 159 mm  
 Product Weight: 44 lbs/20 kg

### OPERATING SUGGESTIONS

Weight on Bit: 18,750–37,500 lbs/8.5–17 T  
 Rotational Speed: 60–100 rpm  
 Air Back Pressure: 29–58 psi/0.2–0.4 MPa

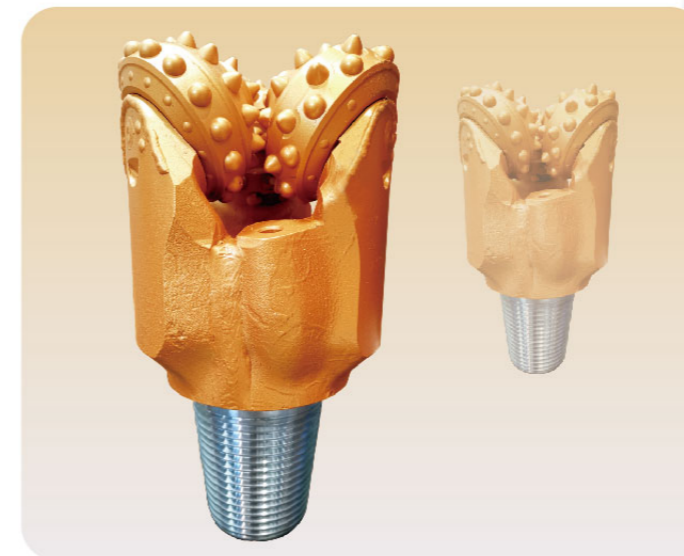
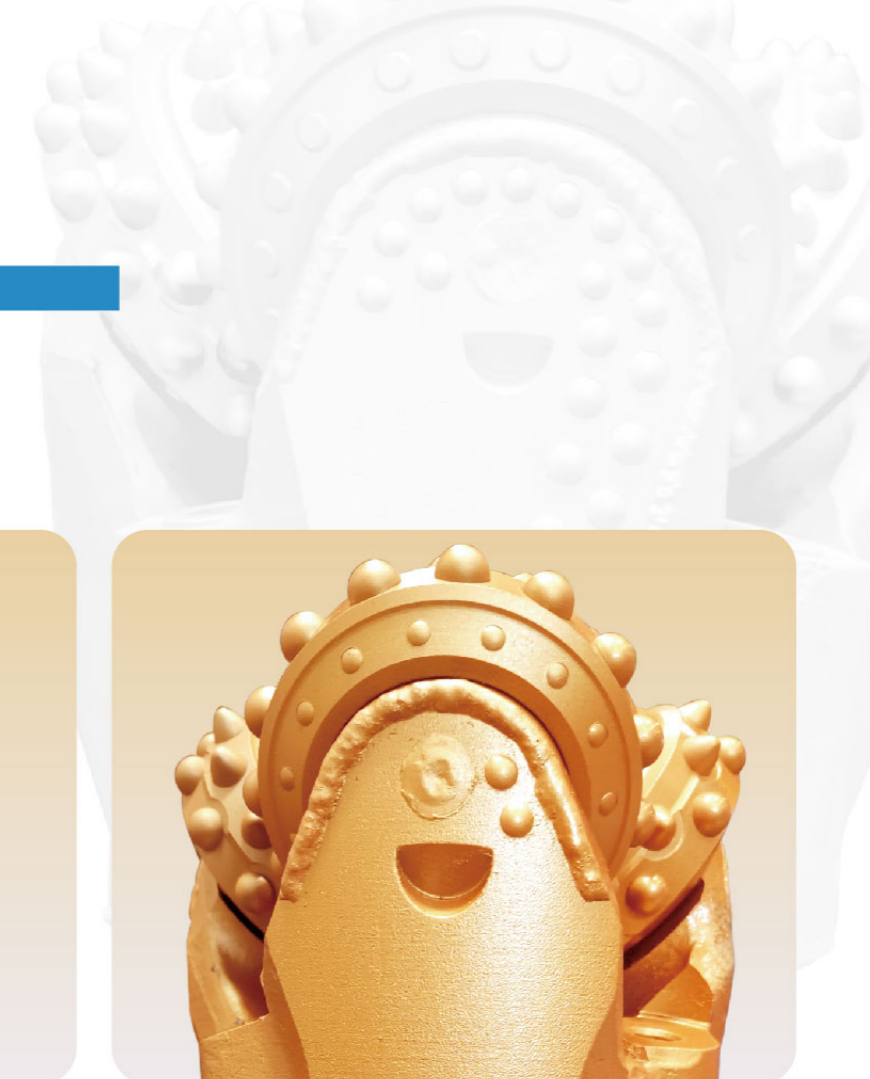
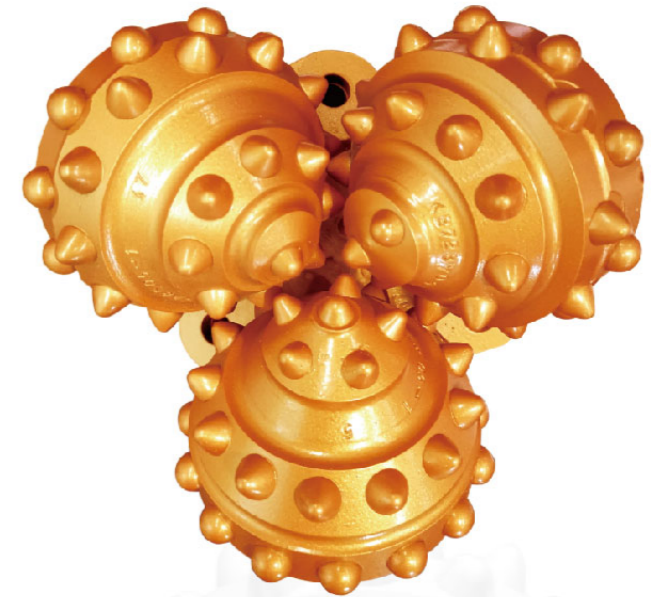

## 6 3/4 SG532

### CUTTING STRUCTURE

Conical on gage & inner rows  
 Designed for medium soft formations with low compressive strength, such as shale, soft limestone, interbedded dolomite, coal ore.  
 Compressive strength: 15,000–23,000 psi/103–158 MPa

### SHIRTTAIL PROTECTION

Hard welding and wear resistant carbide protection on shirrtail lip and lug

### PRODUCT SPECIFICATION

IADC Code: 532  
 Bearing Type: Roller–Ball–Roller–Thrust Button/Open air Bearing  
 Circulation Type: Jet Air  
 Cutting Structure:  
 Inner and Nose Rows: Conical  
 Gage Rows: Conical  
 Gage Bevel Protection: Ovoid  
 Pin Connection: 3 1/2" API REG  
 Metric Bit Diameter: 172 mm  
 Product Weight: 48 lbs/22 kg

### OPERATING SUGGESTIONS

Weight on Bit: 13,500–33,750 lbs/ 6.1–15.3 T  
 Rotational Speed: 80–110 rpm  
 Air Back Pressure: 29–58 psi/0.2–0.4 MPa

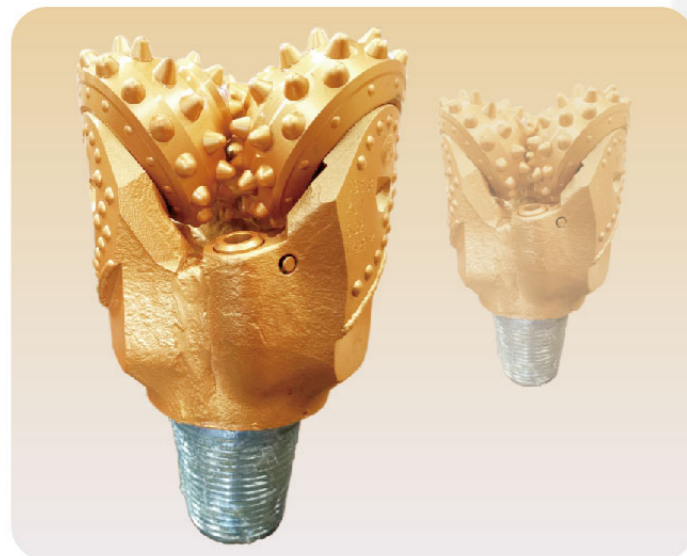

## 7 7/8 SG412GS

### CUTTING STRUCTURE

Chisel on gage, spoon on inner rows, with auxiliary carbide protection.  
 Designed for very soft formations with low compressive strength and high friability such as shale, soft limestone, sandstone, gravel clay, soft dolomite, coal ore.  
 Compressive strength: 4,000–7,000 psi/27–48 MPa

### SHIRTTAIL PROTECTION

Hard metal and wear resistant carbide on shirrtail lip and lug.

### PRODUCT SPECIFICATION

IADC Code: 412  
 Bearing Type: Roller–Ball–Roller–Thrust Button/Open Bearing  
 Circulation Type: Jet Air  
 Cutting Structure:  
 Inner and Nose Rows: Spoon  
 Gage Rows: Chisel  
 Auxiliary Carbide: Spherical  
 Gage Bevel Protection: Ovoid  
 Pin Connection: 4 1/2" API REG  
 Metric Bit Diameter: 200 mm  
 Product Weight: 75 lbs/34 kg

### OPERATING SUGGESTIONS

Weight on Bit: 12.4T / 27,337 lbs MAX  
 Rotational Speed: 90–120 rpm  
 Air Back Pressure: 29–58 psi/0.2–0.4 MPa

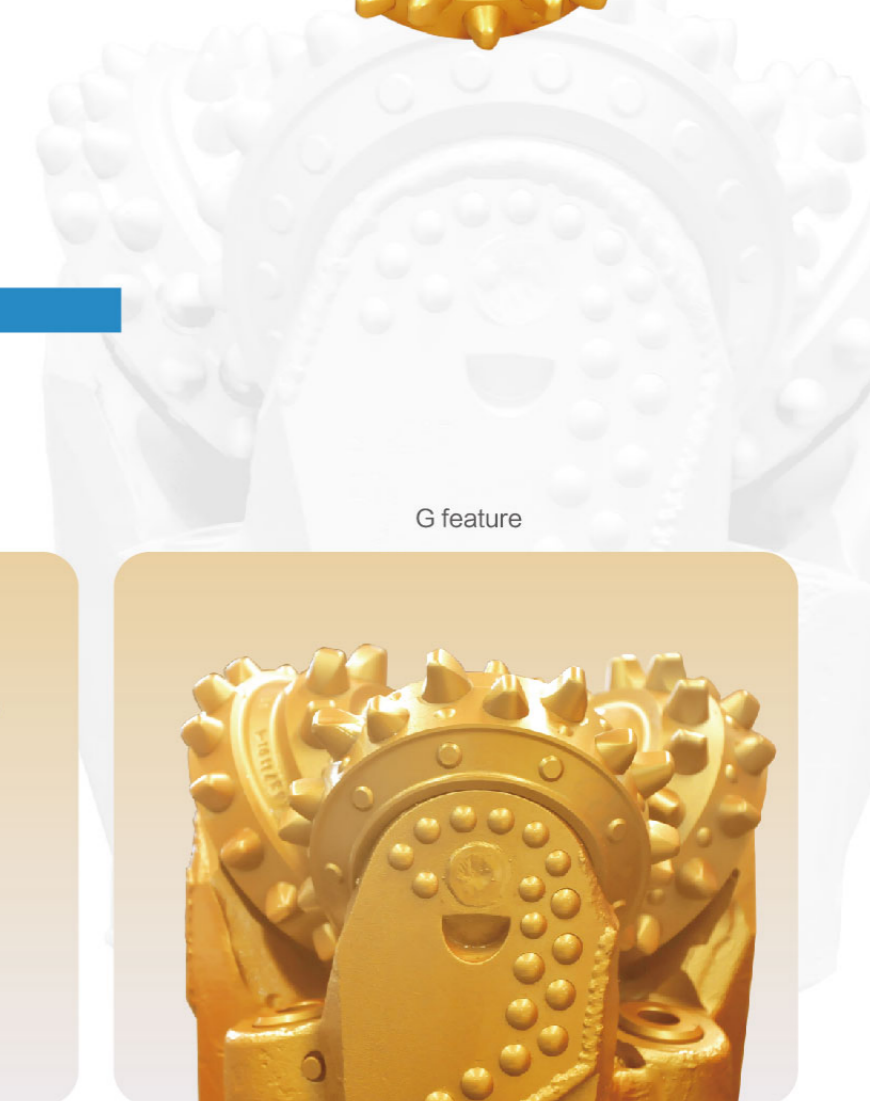

G feature



## 7 7/8 SGV525

### CUTTING STRUCTURE

Chisel on gage, conical on inner rows.

Designed for medium soft formations with low compressive strength, such as shale, soft limestone, interbedded dolomite, coal ore.

Compressive strength: 15,000–23,000 psi/103–158 MPa

### SHIRTTAIL PROTECTION

Hard welding and wear resistant carbide protection on shirrtail lip and lug

### PRODUCT SPECIFICATION

IADC Code: 525

Bearing Type: Roller–Ball–Roller–Thrust Button/Sealed Bearing

Circulation Type: Jet Air

Cutting Structure:

Inner and Nose Rows: Conical

Gage Rows: Chisel

Gage Bevel Protection: Ovoid

Pin Connection: 4 1/2" API REG

Metric Bit Diameter: 200 mm

Product Weight: 75 lbs/34 kg

### OPERATING SUGGESTIONS

Weight on Bit: 15,750–39,380 lbs/ 7.2–17.9 T

Rotational Speed: 80–110 rpm

Air Back Pressure: 29–58 psi/0.2–0.4 MPa

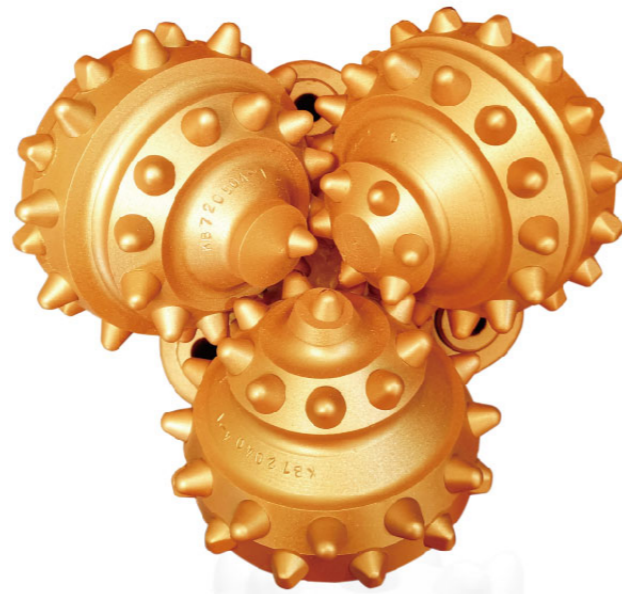

## 7 7/8 SGV635

### CUTTING STRUCTURE

Spherical on gage, double spherical on inner rows.

Designed for high compressive strength, medium hard and abrasive formations, such as limestone, sandstone, interbedded dolomite.

Compressive strength: 29,000–38,000 psi/200–262 MPa

### SHIRTTAIL PROTECTION

Hard welding and wear resistant carbide protection on shirrtail lip and lug

### PRODUCT SPECIFICATION

IADC Code: 635

Bearing Type: Roller–Ball–Roller–Thrust Button/Sealed Bearing

Circulation Type: Jet Air

Cutting Structure:

Inner and Nose Rows: Double spherical

Gage Rows: Spherical

Gage Bevel Protection: Ovoid

Pin Connection: 4 1/2" API REG

Metric Bit Diameter: 200 mm

Product Weight: 75 lbs/34 kg

### OPERATING SUGGESTIONS

Weight on Bit: 23,630–47,250 lbs/10.7–21.4 T

Rotational Speed: 60–100 rpm

Air Back Pressure: 29–58 psi/0.2–0.4 MPa

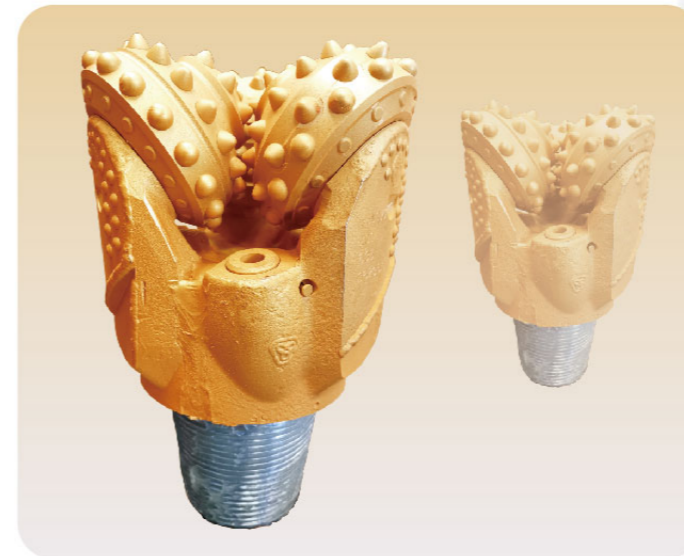
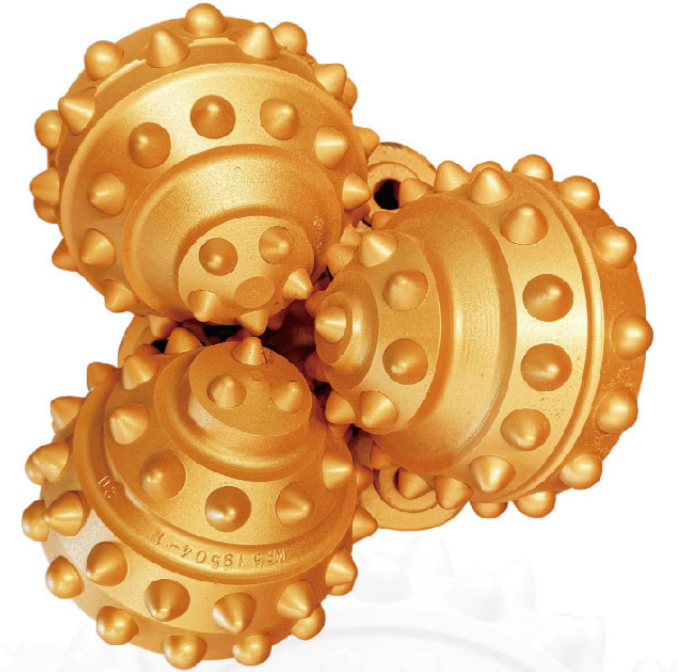

## 7 7/8 SGV735

### CUTTING STRUCTURE

Spherical on gage, double spherical on inner rows.  
Designed for high compressive strength, hard and abrasive formations, such as granite, limestone, sandstone, dolomite.  
Compressive strength: 43,000–52,000 psi/296–358 MPa

### SHIRTTAIL PROTECTION

Hard welding and wear resistant carbide protection on shirrtail lip and lug

### PRODUCT SPECIFICATION

IADC Code: 735  
Bearing Type: Roller–Ball–Roller–Thrust Button/Sealed Bearing  
Circulation Type: Jet Air  
Cutting Structure:  
Inner and Nose Rows: Double spherical and conical  
Gage Rows: Conical  
Gage Bevel Protection: Ovoid  
Pin Connection: 4 1/2" API REG  
Metric Bit Diameter: 200 mm  
Product Weight: 75 lbs/34 kg

### OPERATING SUGGESTIONS

Weight on Bit: 31,500–55,130 lbs/14.3–25 T  
Rotational Speed: 60–90 rpm  
Air Back Pressure: 29–58 psi/0.2–0.4 MPa

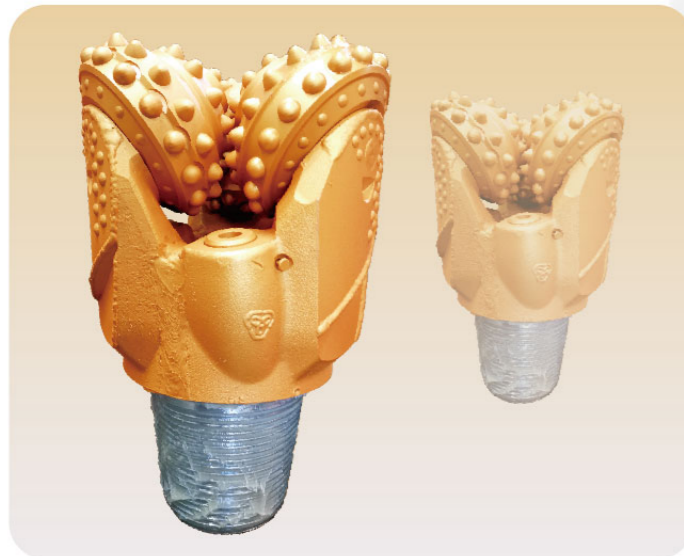
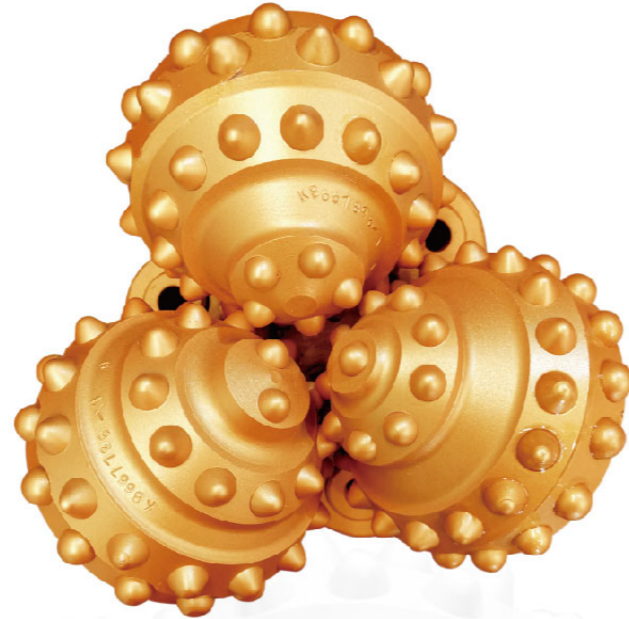

## 7 7/8 SGA545R

### CUTTING STRUCTURE

Conical on gage and inner rows  
Designed for soft formations with low compressive strength, such as shale, soft limestone, interbedded dolomite, coal ore.  
Compressive strength: 18,000–27,000 psi/124–186 MPa

### SHIRTTAIL PROTECTION

Hard welding and wear resistant carbide protection on shirrtail lip and lug

### PRODUCT SPECIFICATION

IADC Code: 545  
Bearing Type: Roller–Ball–Roller–Thrust Button/Sealed Bearing  
Circulation Type: Jet Air  
Cutting Structure:  
Inner and Nose Rows: Conical  
Gage Rows: Conical  
Gage Bevel Protection: Ovoid  
Pin Connection: 4 1/2" API REG  
Metric Bit Diameter: 200 mm  
Product Weight: 75 lbs/34 kg

### OPERATING SUGGESTIONS

Weight on Bit: 15,750–39,380 lbs/ 7.2–17.9 T  
Rotational Speed: 80–110 rpm  
Air Back Pressure: 29–58 psi/0.2–0.4 MPa

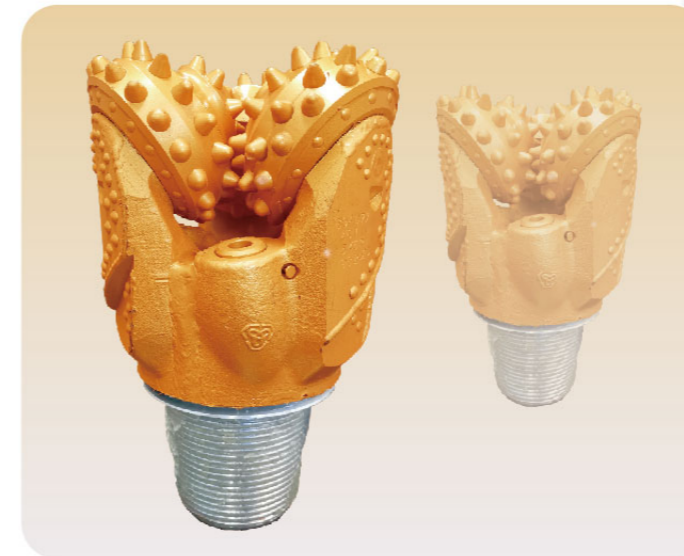
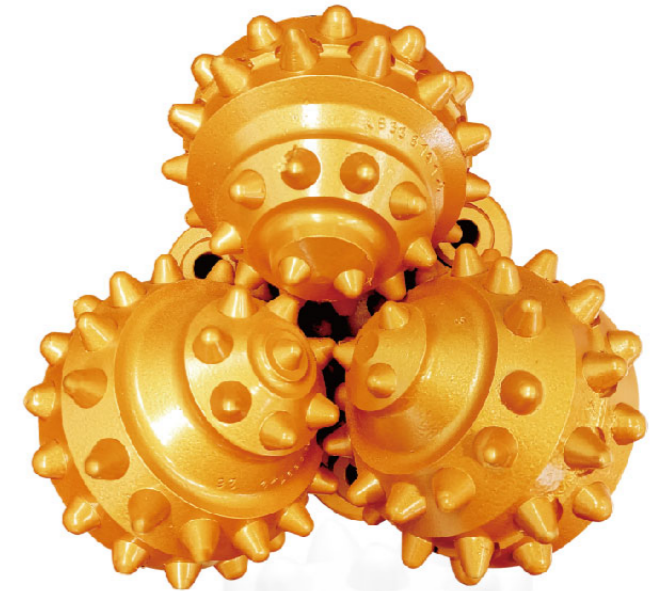

## 7 7/8 SGA635

### CUTTING STRUCTURE

Conical on gage, double spherical and conical on inner rows.  
 Designed for high compressive strength, medium hard and abrasive formations, such as limestone, sandstone, interbedded dolomite.  
 Compressive strength: 29,000–38,000 psi/200–262 MPa

### SHIRTTAIL PROTECTION

Hard metal and wear resistant carbide on shirrtail lip and lug.

### PRODUCT SPECIFICATION

IADC Code: 635  
 Bearing Type: Roller–Ball–Roller–Thrust Button/Sealed Bearing  
 Circulation Type: Jet Air  
 Cutting Structure:  
 Inner and Nose Rows: Double spherical and conical  
 Gage Rows: Conical  
 Gage Bevel Protection: Ovoid  
 Pin Connection: 4 1/2" API REG  
 Metric Bit Diameter: 200 mm  
 Product Weight: 75 lbs/34 kg

### OPERATING SUGGESTIONS

Weight on Bit: 12.4T / 27,337 lbs MAX  
 Rotational Speed: 60–100 rpm  
 Air Back Pressure: 29–58 psi/0.2–0.4 MPa

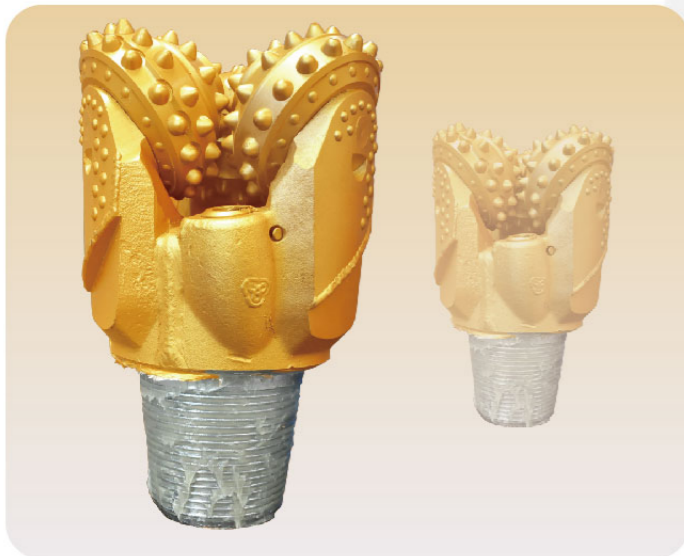

## 8 1/2 SGA635

### CUTTING STRUCTURE

Conical on gage, double spherical on inner rows.  
 Designed for high compressive strength, medium hard and abrasive formations, such as limestone, sandstone, interbedded dolomite.  
 Compressive strength: 29,000–38,000 psi/200–262 MPa

### SHIRTTAIL PROTECTION

Hard welding and wear resistant carbide protection on shirrtail lip and lug.

### PRODUCT SPECIFICATION

IADC Code: 635  
 Bearing Type: Roller–Ball–Roller–Thrust Button/Sealed Bearing  
 Circulation Type: Jet Air  
 Cutting Structure:  
 Inner and Nose Rows: Double spherical  
 Gage Rows: Conical  
 Gage Bevel Protection: Ovoid  
 Pin Connection: 4 1/2" API REG  
 Metric Bit Diameter: 216 mm  
 Product Weight: 84 lbs/38 kg

### OPERATING SUGGESTIONS

Weight on Bit: 25,500–51,000 lbs/11.6–23.1 T  
 Rotational Speed: 60–100 rpm  
 Air Back Pressure: 29–58 psi/0.2–0.4 MPa

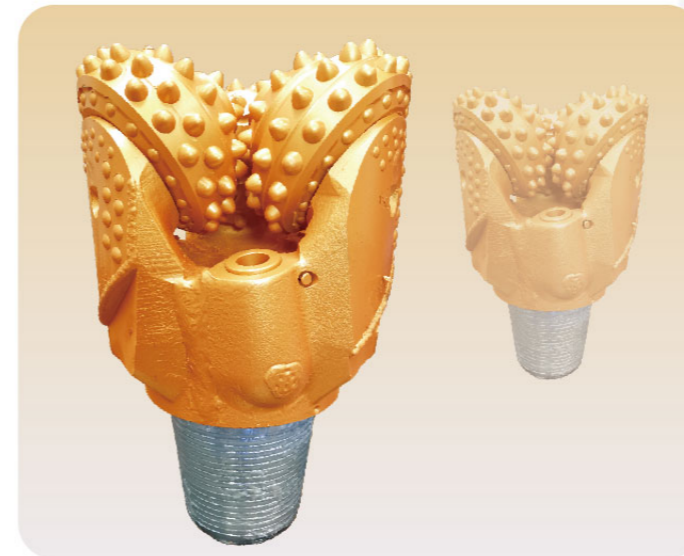
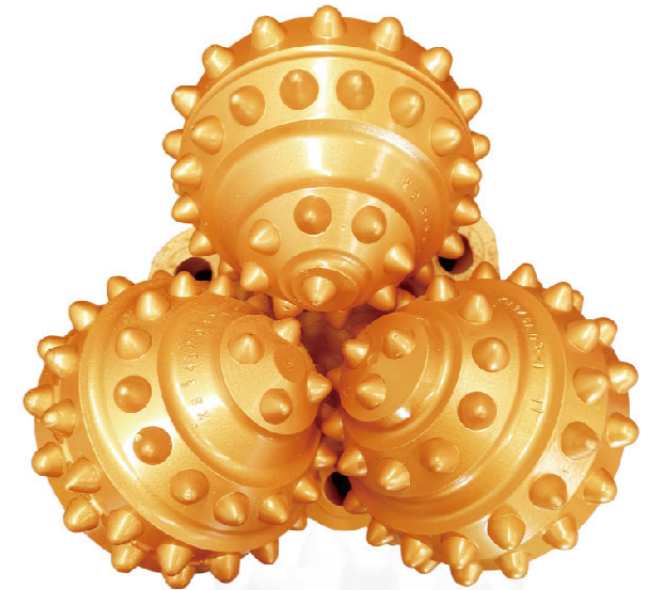

## 9 SGV525

### CUTTING STRUCTURE

Off chisel on gage, conical on inner rows.

Designed for medium soft formations with low compressive strength, such as shale, soft limestone, interbedded dolomite, coal ore.

Compressive strength: 12,000–18,000 psi/82–124 MPa

### SHIRTTAIL PROTECTION

Hard welding and wear resistant carbide protection on shirrtail lip and lug

### PRODUCT SPECIFICATION

IADC Code: 525  
 Bearing Type: Roller–Ball–Roller–Thrust Button/Sealed Bearing  
 Circulation Type: Jet Air  
 Cutting Structure:  
 Inner and Nose Rows: Conical  
 Gage Rows: Off chisel  
 Gage Bevel Protection: Ovoid  
 Pin Connection: 4 1/2" API REG  
 Metric Bit Diameter: 229 mm  
 Product Weight: 110 lbs/50 kg

### OPERATING SUGGESTIONS

Weight on Bit: 12,000–42,000 lbs/ 5.4–19 T  
 Rotational Speed: 80–110 rpm  
 Air Back Pressure: 29–58 psi/0.2–0.4 MPa

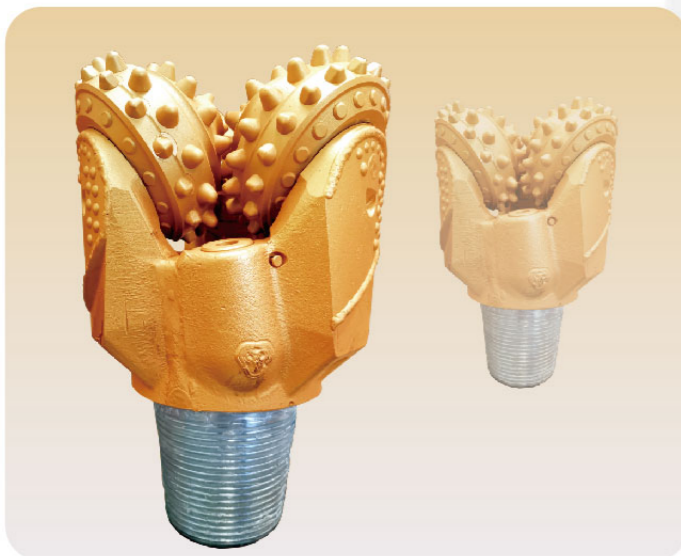

## 9 SGV545RF

### CUTTING STRUCTURE

Conical on gage and inner rows.

Designed for soft formations with low compressive strength, such as shale, soft limestone, interbedded dolomite, coal ore.

Compressive strength: 18,000–27,000 psi/124–186 MPa

### SHIRTTAIL PROTECTION

Hard metal and wear resistant carbide on shirrtail lip and lug.

### PRODUCT SPECIFICATION

IADC Code: 545  
 Bearing Type: Roller–Ball–Roller–Thrust Button/Sealed Bearing  
 Circulation Type: Jet Air  
 Cutting Structure:  
 Inner and Nose Rows: Conical  
 Gage Rows: Conical  
 Gage Bevel Protection: Ovoid  
 Auxiliary Carbide: Spherical  
 Pin Connection: 4 1/2" API REG  
 Metric Bit Diameter: 229 mm  
 Product Weight: 110 lbs/50 kg

### OPERATING SUGGESTIONS

Weight on Bit: 13.5T / 29,762 lbs MAX  
 Rotational Speed: 80–110 rpm  
 Air Back Pressure: 29–58 psi/0.2–0.4 MPa

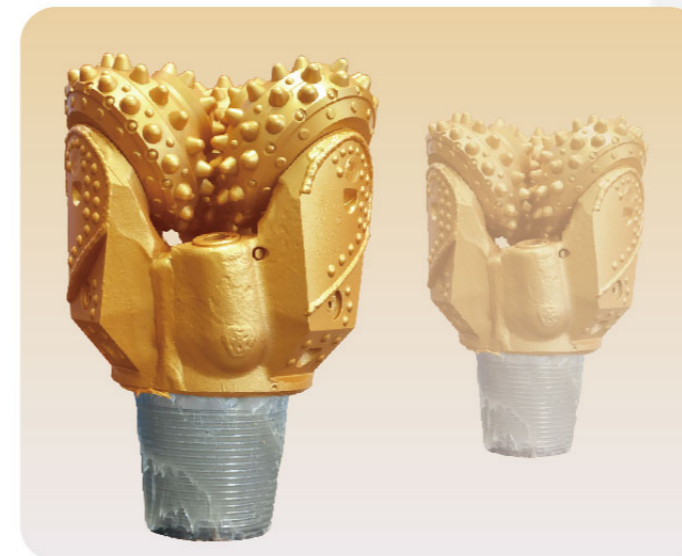

R feature

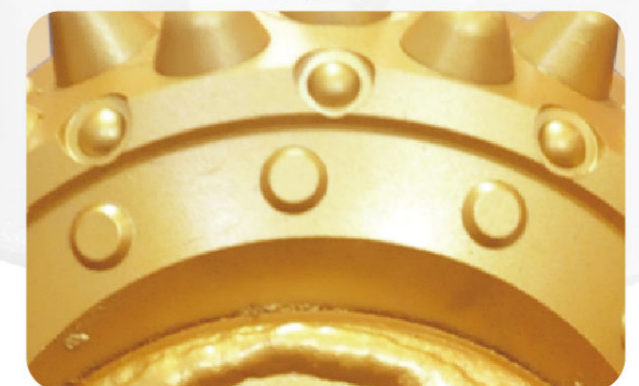

F feature

## 9 SGV415FS

### CUTTING STRUCTURE

Wedge on gage, conical on inner rows, with auxiliary carbide protection.

Designed for very soft formations with low compressive strength and high friability such as shale, soft limestone, sandstone, gravel clay, soft dolomite, coal ore.

Compressive strength: 4,000–7,000 psi/27–48 MPa

### SHIRTTAIL PROTECTION

Hard metal and wear resistant carbide on shirrtail lip and lug.

### PRODUCT SPECIFICATION

IADC Code: 415  
 Bearing Type: Roller–Ball–Roller–Thrust Button/Sealed Bearing  
 Circulation Type: Jet Air  
 Cutting Structure:  
 Inner and Nose Rows: Conical  
 Gage Rows: Wedge  
 Auxiliary Carbide: Spherical  
 Gage Bevel Protection: Ovoid  
 Pin Connection: 4 1/2" API REG  
 Metric Bit Diameter: 229 mm  
 Product Weight: 110 lbs/50 kg

### OPERATING SUGGESTIONS

Weight on Bit: 13.5T / 29,762 lbs MAX  
 Rotational Speed: 90–120 rpm  
 Air Back Pressure: 29–58 psi/0.2–0.4 MPa

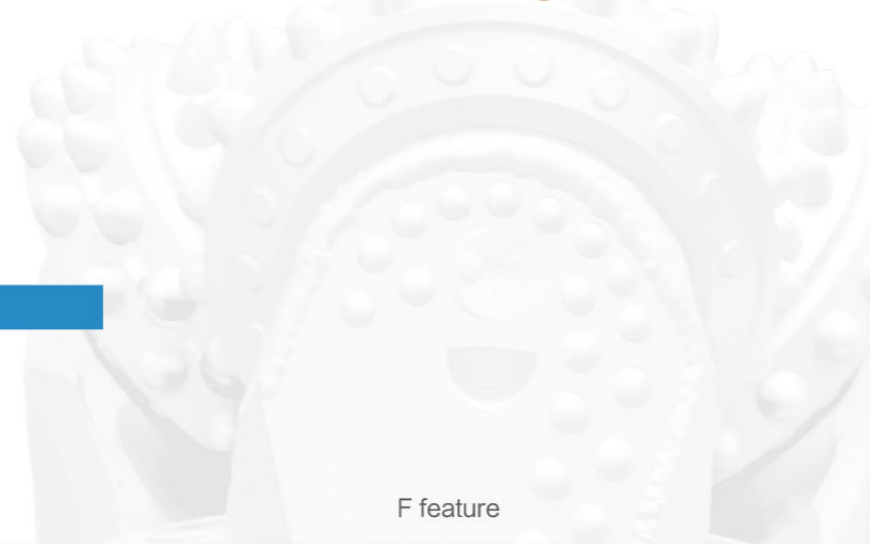

F feature

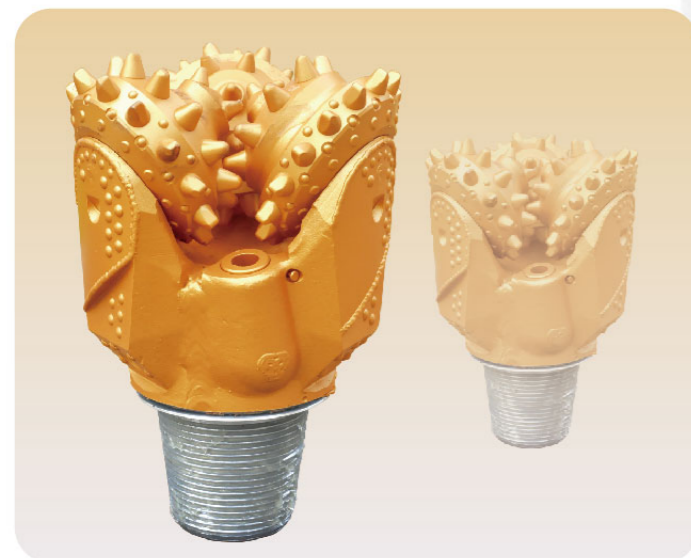

## 9 SGV435FS

### CUTTING STRUCTURE

Wedge on gage, conical on inner rows, with auxiliary carbide protection.

Designed for very soft formations with low compressive strength and high friability such as shale, soft limestone, sandstone, gravel clay, soft dolomite, coal ore.

Compressive strength: 6,000–9,000 psi/41–62 MPa

### SHIRTTAIL PROTECTION

Hard metal and wear resistant carbide on shirrtail lip and lug.

### PRODUCT SPECIFICATION

IADC Code: 435  
 Bearing Type: Roller–Ball–Roller–Thrust Button/Sealed Bearing  
 Circulation Type: Jet Air  
 Cutting Structure:  
 Inner and Nose Rows: Conical  
 Gage Rows: Wedge  
 Auxiliary Carbide: Spherical  
 Gage Bevel Protection: Ovoid  
 Pin Connection: 4 1/2" API REG  
 Metric Bit Diameter: 229 mm  
 Product Weight: 110 lbs/50 kg

### OPERATING SUGGESTIONS

Weight on Bit: 13.5T / 29,762 lbs MAX  
 Rotational Speed: 90–120 rpm  
 Air Back Pressure: 29–58 psi/0.2–0.4 MPa

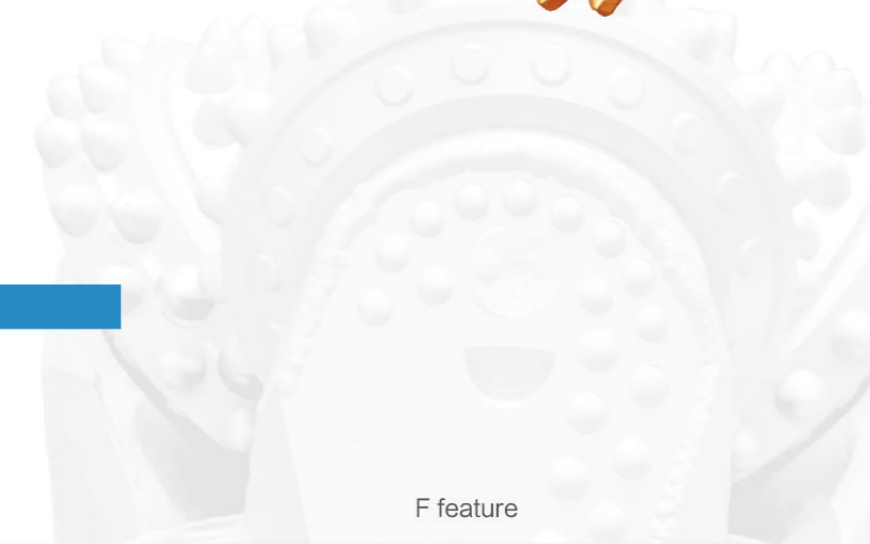

F feature



## 9 SGV635RF

### CUTTING STRUCTURE

Conical on gage, spherical and conical on inner rows.  
Designed for high compressive strength, medium hard and abrasive formations, such as limestone, sandstone, interbedded dolomite.  
Compressive strength: 29,000–38,000 psi/200–262 MPa

### SHIRTTAIL PROTECTION

Hard metal and wear resistant carbide on shirrtail lip and lug.

### PRODUCT SPECIFICATION

IADC Code: 635  
Bearing Type: Roller–Ball–Roller–Thrust Button/Sealed Bearing  
Circulation Type: Jet Air  
Cutting Structure:  
Inner and Nose Rows: Spherical and conical  
Gage Rows: Conical  
Gage Bevel Protection: Ovoid  
Auxiliary Carbide: Spherical  
Pin Connection: 4 1/2" API REG  
Metric Bit Diameter: 229 mm  
Product Weight: 110 lbs/50 kg

### OPERATING SUGGESTIONS

Weight on Bit: 13.5T / 29,762 lbs MAX  
Rotational Speed: 60–100rpm  
Air Back Pressure: 29–58 psi/0.2–0.4 MPa

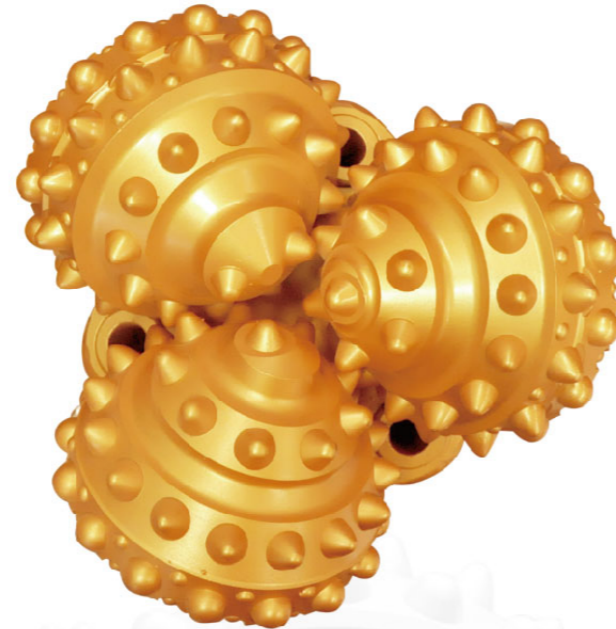

R feature



F feature

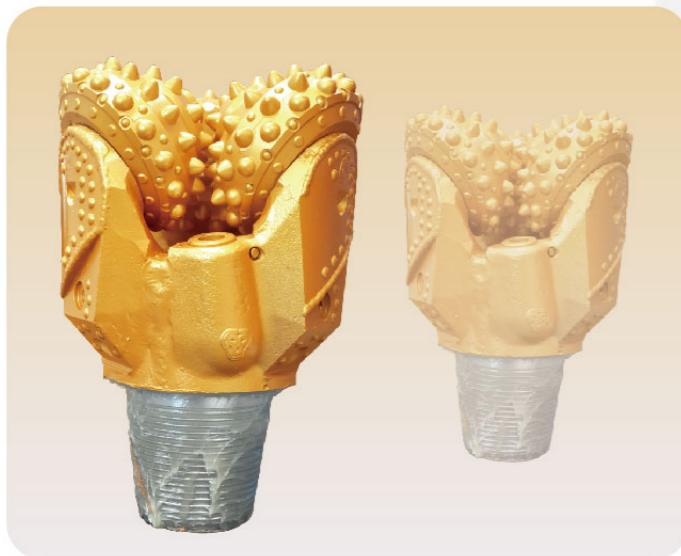

## 9 SGV735RF

### CUTTING STRUCTURE

Spherical on gage, double spherical on inner rows, with auxiliary carbide protection.  
Designed for high compressive strength, hard and abrasive formations, such as granite, limestone, sandstone, dolomite.  
Compressive strength: 43,000–52,000 psi/296–358 MPa

### SHIRTTAIL PROTECTION

Hard metal and wear resistant carbide on shirrtail lip and lug.

### PRODUCT SPECIFICATION

IADC Code: 735  
Bearing Type: Roller–Ball–Roller–Thrust Button/Sealed Bearing  
Circulation Type: Jet Air  
Cutting Structure:  
Inner and Nose Rows: Double spherical  
Gage Rows: Spherical  
Auxiliary Carbide: Spherical  
Gage Bevel Protection: Ovoid  
Pin Connection: 4 1/2" API REG  
Metric Bit Diameter: 229 mm  
Product Weight: 110 lbs/50 kg

### OPERATING SUGGESTIONS

Weight on Bit: 13.5T / 29,762 lbs MAX  
Rotational Speed: 60–90 rpm  
Air Back Pressure: 29–58 psi/0.2–0.4 MPa

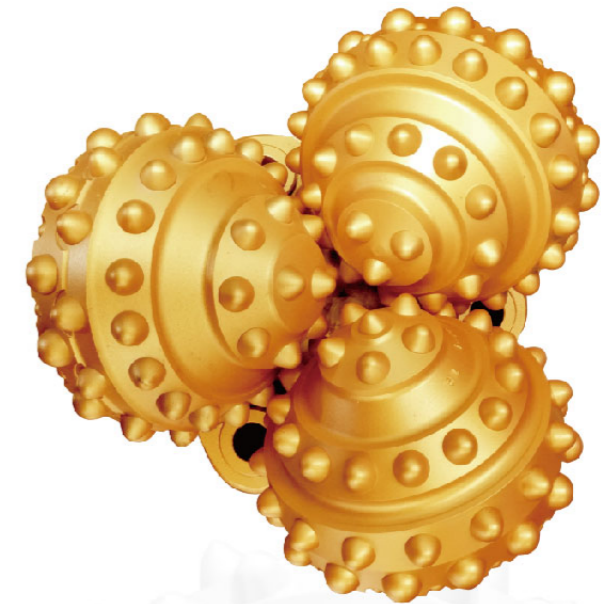

R feature



F feature

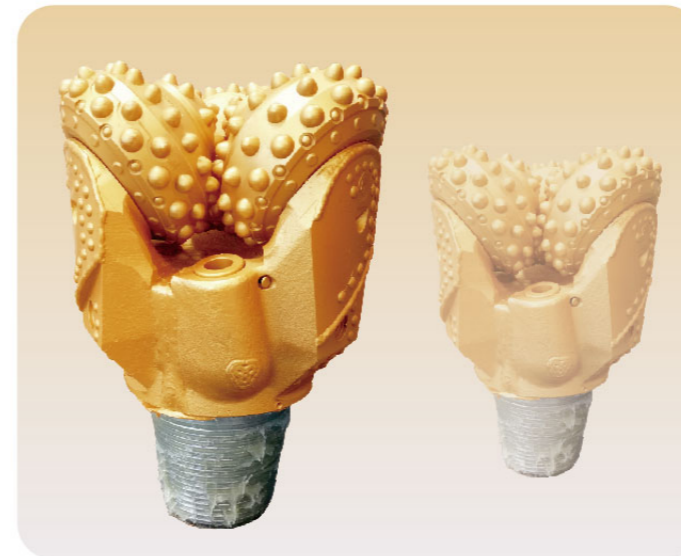
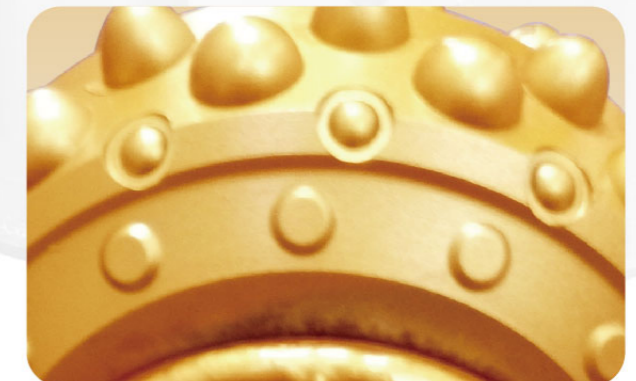



## 9 7/8 SGV435R

### CUTTING STRUCTURE

Chisel on gage, double spherical on inner rows  
Designed for very soft formations with low compressive strength and high friability such as shale, soft limestone, sandstone, gravel clay, soft dolomite, coal ore.  
Compressive strength: 6,000–9,000 psi/41–62 MPa

### SHIRTTAIL PROTECTION

Hard welding and wear resistant carbide protection on shirrtail lip and lug, anti-reversal insert protection.

### PRODUCT SPECIFICATION

IADC Code: 435  
Bearing Type: Roller–Ball–Roller–Thrust Button/Sealed Bearing  
Circulation Type: Jet Air  
Cutting Structure:  
Inner and Nose Rows: Double spherical  
Gage Bevel Protection: Ovoid  
Pin Connection: 6 5/8" API REG  
Metric Bit Diameter: 251 mm  
Product Weight: 143 lbs/ 65 kg

### OPERATING SUGGESTIONS

Weight on Bit: 9,875–39,500 lbs/ 4.5–17.9 T  
Rotational Speed: 90–120 rpm  
Air Back Pressure: 29–58 psi/0.2–0.4 MPa

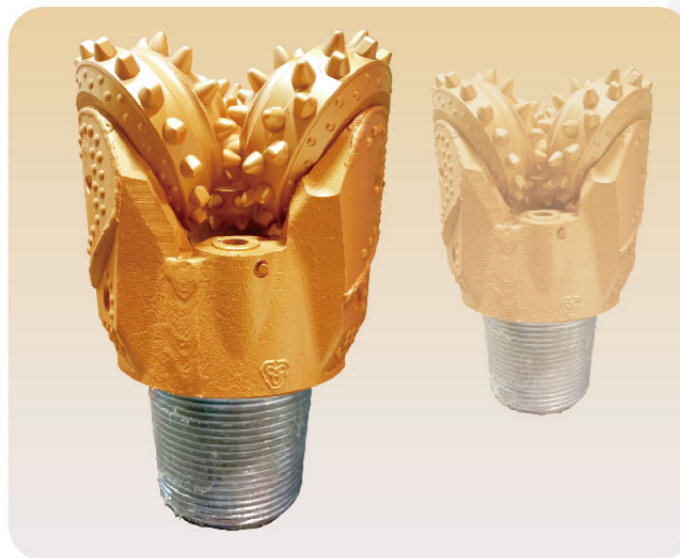

## 9 7/8 SGV435RF

### CUTTING STRUCTURE

Off–chisel on gage, conical on inner rows, with auxiliary carbide protection.  
Designed for very soft formations with low compressive strength and high friability such as shale, soft limestone, sandstone, gravel clay, soft dolomite, coal ore.  
Compressive strength: 6,000–9,000 psi/41–62 MPa

### SHIRTTAIL PROTECTION

Hard metal and wear resistant carbide on shirrtail lip and lug.

### PRODUCT SPECIFICATION

IADC Code: 435  
Bearing Type: Roller–Ball–Roller–Thrust Button/Sealed Bearing  
Circulation Type: Jet Air  
Cutting Structure:  
Inner and Nose Rows: Conical  
Gage Rows: Off–chisel  
Auxiliary Carbide: Spherical  
Gage Bevel Protection: Ovoid  
Pin Connection: 6 5/8" API REG  
Metric Bit Diameter: 251 mm  
Product Weight: 143 lbs/65 kg

### OPERATING SUGGESTIONS

Weight on Bit: 20.0T / 44,093 lbs MAX  
Rotational Speed: 90–120 rpm  
Air Back Pressure: 29–58 psi/0.2–0.4 MPa



R feature

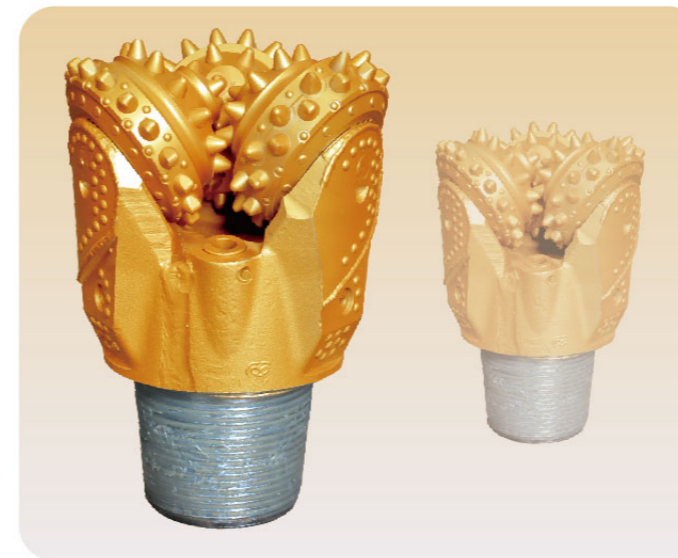

F feature



## 9 7/8 SGV535RF

### CUTTING STRUCTURE

Off-chisel on gage, conical on inner rows, with auxiliary carbide protection.

Designed for soft formations with low compressive strength, such as shale, soft limestone, interbedded dolomite, coal ore.

Compressive strength: 15,000–23,000 psi/103–158 MPa

### SHIRTTAIL PROTECTION

Hard metal and wear resistant carbide on shirrtail lip and lug.

### PRODUCT SPECIFICATION

IADC Code: 535  
 Bearing Type: Roller–Ball–Roller–Thrust Button/Sealed Bearing  
 Circulation Type: Jet Air  
 Cutting Structure:  
 Inner and Nose Rows: Conical  
 Gage Rows: Off–chisel  
 Auxiliary Carbide: Spherical  
 Gage Bevel Protection: Ovoid  
 Pin Connection: 6 5/8" API REG  
 Metric Bit Diameter: 251 mm  
 Product Weight: 143 lbs/65 kg

### OPERATING SUGGESTIONS

Weight on Bit: 20.0T / 44,093 lbs MAX  
 Rotational Speed: 80–110 rpm  
 Air Back Pressure: 29–58 psi/0.2–0.4 MPa



R feature



F feature

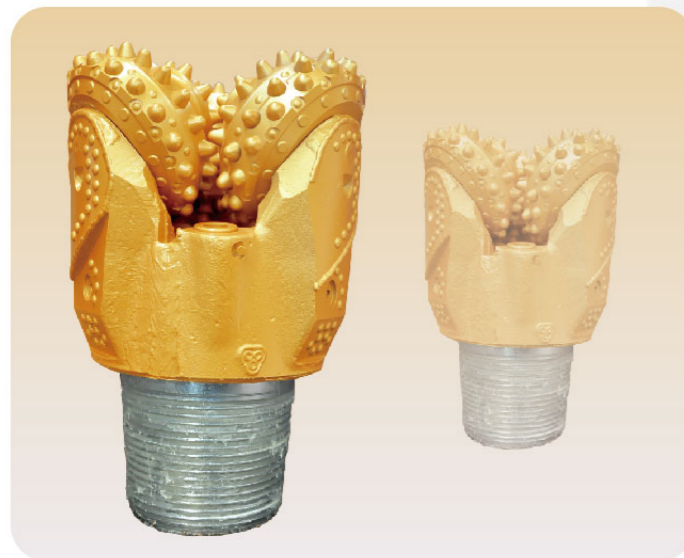
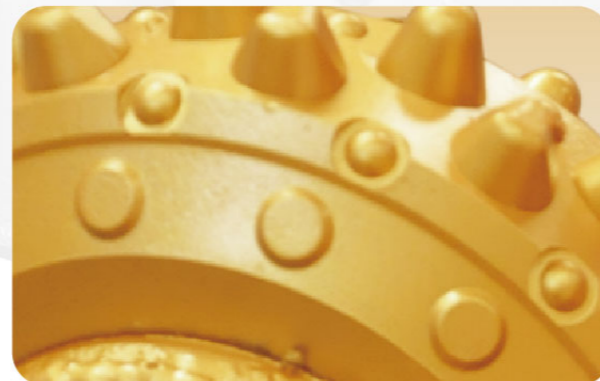

## 9 7/8 SGV615RF

### CUTTING STRUCTURE

Conical & spherical on gage, conical on inner rows, with auxiliary carbide protection.

Designed for high compressive strength, medium hard and abrasive formations, such as limestone, sandstone, interbedded dolomite.

Compressive strength: 23,000–30,000 psi/158–206 MPa

### SHIRTTAIL PROTECTION

Hard metal and wear resistant carbide on shirrtail lip and lug.

### PRODUCT SPECIFICATION

IADC Code: 615  
 Bearing Type: Roller–Ball–Roller–Thrust Button/Sealed Bearing  
 Circulation Type: Jet Air  
 Cutting Structure:  
 Inner and Nose Rows: Conical  
 Gage Rows: Conical & spherical  
 Auxiliary Carbide: Spherical  
 Gage Bevel Protection: Ovoid  
 Pin Connection: 6 5/8" API REG  
 Metric Bit Diameter: 251 mm  
 Product Weight: 143 lbs/65 kg

### OPERATING SUGGESTIONS

Weight on Bit: 20.0T / 44,093 lbs MAX  
 Rotational Speed: 60–100 rpm  
 Air Back Pressure: 29–58 psi/0.2–0.4 MPa



R feature



F feature

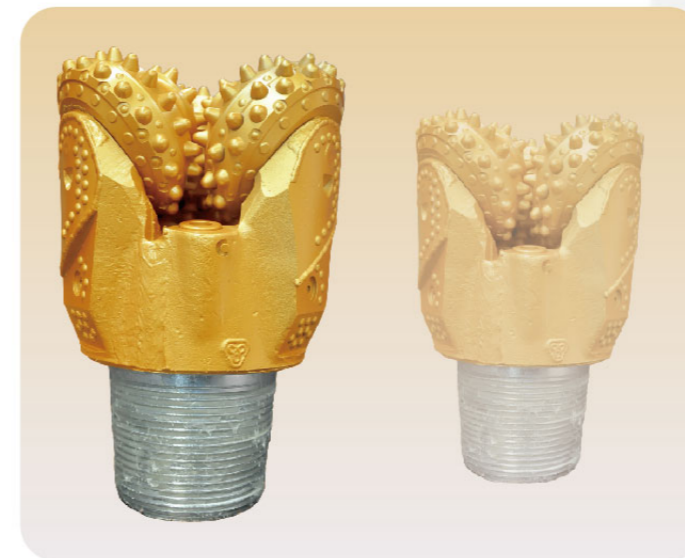

## 9 7/8 SGV715

### CUTTING STRUCTURE

Conical on gage, double spherical on inner rows.  
Designed for high compressive strength, hard and abrasive formations, such as granite, limestone, sandy shale, dolomite, chert.  
Compressive strength: 37,000–44,000 psi/255–303 MPa

### SHIRTTAIL PROTECTION

Hard welding and wear resistant carbide protection on shirrtail lip and lug

### PRODUCT SPECIFICATION

IADC Code: 715  
Bearing Type: Roller–Ball–Roller–Thrust/Composite Sealed Bearing  
Circulation Type: Jet Air  
Cutting Structure:  
Inner Rows: Double spherical  
Gage Rows: Conical  
Gage Bevel Protection: Flat  
Pin Connection: 6 5/8" API REG  
Metric Bit Diameter: 251 mm  
Product Weight: 143 lbs/65 kg

### OPERATING SUGGESTIONS

Weight on Bit: 39,500–59,250 lbs/17.9–26.9 T  
Rotational Speed: 60–90 rpm  
Air Back Pressure: 29–58 psi/0.2–0.4 MPa

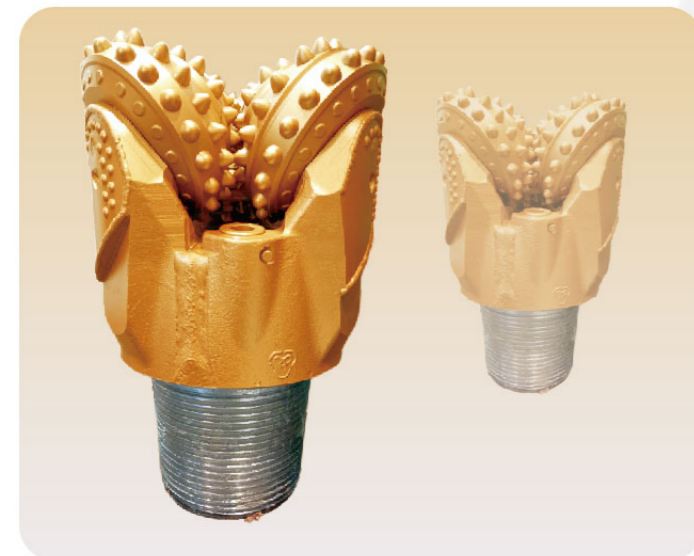

## 9 7/8 SGV725

### CUTTING STRUCTURE

Conical on gage and inner rows.  
Designed for high compressive strength, hard and abrasive formations, such as granite, limestone, sandstone, dolomite.  
Compressive strength: 40,000–48,000 psi/275–331 MPa

### SHIRTTAIL PROTECTION

Hard metal and wear resistant carbide on shirrtail lip and lug.

### PRODUCT SPECIFICATION

IADC Code: 725  
Bearing Type: Roller–Ball–Roller–Thrust Button/Sealed Bearing  
Circulation Type: Jet Air  
Cutting Structure:  
Inner and Nose Rows: Conical  
Gage Rows: Conical  
Gage Bevel Protection: Ovoid  
Pin Connection: 6 5/8" API REG  
Metric Bit Diameter: 251 mm  
Product Weight: 143 lbs/65 kg

### OPERATING SUGGESTIONS

Weight on Bit: 20.0T / 44,093 lbs MAX  
Rotational Speed: 60–90 rpm  
Air Back Pressure: 29–58 psi/0.2–0.4 MPa

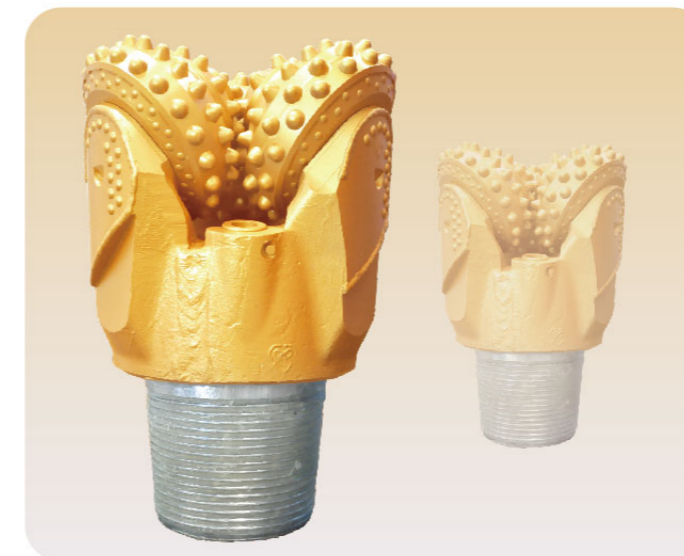
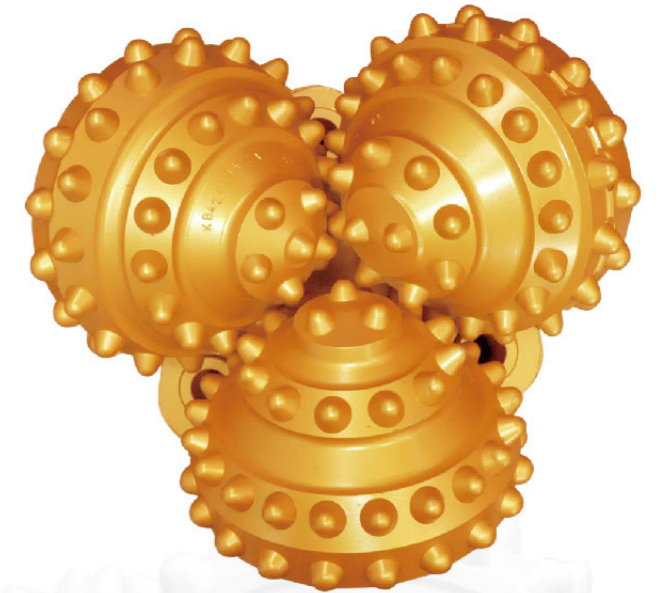

## 9 7/8 SGV725G

### CUTTING STRUCTURE

Conical on gage, double spherical on inner rows.  
Designed for high compressive strength, hard and abrasive formations, such as granite, limestone, sandy shale, dolomite, chert.  
Compressive strength: 40,000–48,000 psi/276–331 MPa

### SHIRTTAIL PROTECTION

Hard welding and wear resistant carbide protection on shirrtail lip and lug

### PRODUCT SPECIFICATION

IADC Code: 725  
Bearing Type: Roller–Ball–Roller–Thrust/Composite Sealed Bearing  
Circulation Type: Jet Air  
Cutting Structure:  
Inner Rows: Double spherical  
Gage Rows: Conical  
Gage Bevel Protection: Flat  
Pin Connection: 6 5/8" API REG  
Metric Bit Diameter: 251 mm  
Product Weight: 143 lbs/65 kg

### OPERATING SUGGESTIONS

Weight on Bit: 39,500–59,250 lbs/17.9–26.9 T  
Rotational Speed: 60–90 rpm  
Air Back Pressure: 29–58 psi/0.2–0.4 MPa

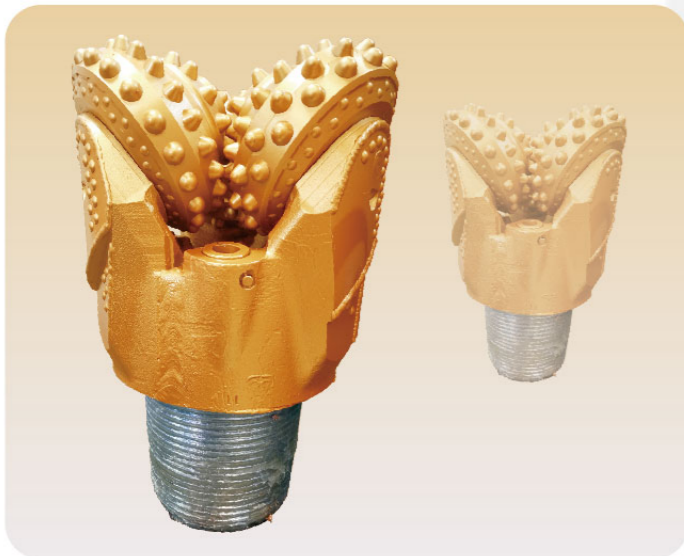
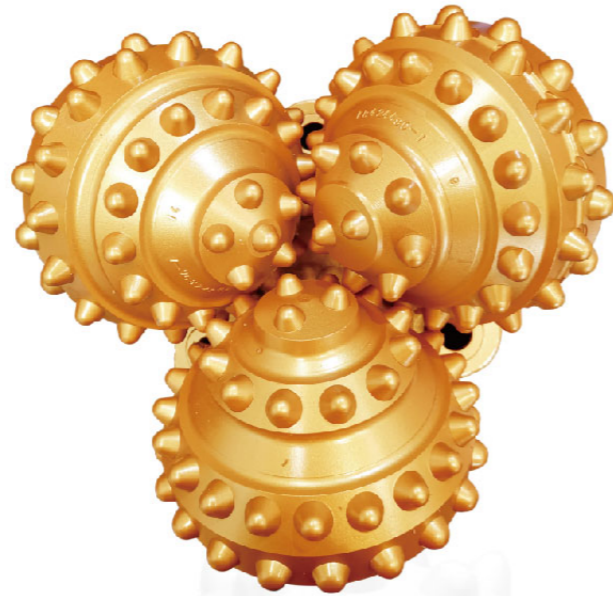

## 9 7/8 SGA515RS

### CUTTING STRUCTURE

Chisel on gage, conical on inner rows.  
Designed for medium soft formations with low compressive strength, such as shale, soft limestone, interbedded dolomite, coal ore.  
Compressive strength: 12,000–18,000 psi/82–124 MPa

### SHIRTTAIL PROTECTION

Hard welding and wear resistant carbide protection on shirrtail lip and lug

### PRODUCT SPECIFICATION

IADC Code: 515  
Bearing Type: Roller–Ball–Roller–Thrust Button/Sealed Bearing  
Circulation Type: Jet Air  
Cutting Structure:  
Inner and Nose Rows: Conical  
Gage Rows: Chisel  
Gage Bevel Protection: Ovoid  
Pin Connection: 6 5/8" API REG  
Metric Bit Diameter: 251 mm  
Product Weight: 143 lbs/65 kg

### OPERATING SUGGESTIONS

Weight on Bit: 13,500–45,000 lbs/6.1–22.4 T  
Rotational Speed: 80–110 rpm  
Air Back Pressure: 29–58 psi/0.2–0.4 MPa

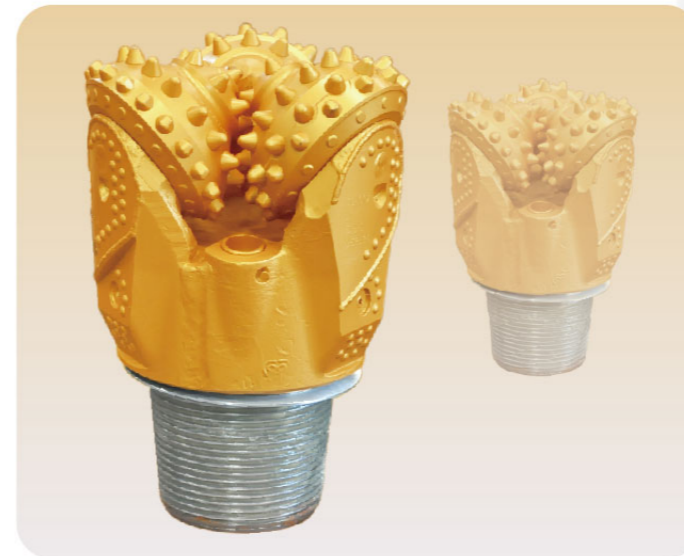

## 9 7/8 SGA635RF

### CUTTING STRUCTURE

Conical on gage, double spherical and conical on inner rows, with auxiliary carbide protection.

Designed for high compressive strength, medium hard and abrasive formations, such as limestone, sandstone, interbedded dolomite.

Compressive strength: 29,000–38,000 psi/200–262 MPa

### SHIRTTAIL PROTECTION

Hard metal and wear resistant carbide on shirrtail lip and lug.

### PRODUCT SPECIFICATION

IADC Code: 635

Bearing Type: Roller–Ball–Roller–Thrust Button/Sealed Bearing

Circulation Type: Jet Air

Cutting Structure:

Inner and Nose Rows: Double spherical and conical

Gage Rows: Conical

Auxiliary Carbide: Spherical

Gage Bevel Protection: Ovoid

Pin Connection: 6 5/8" API REG

Metric Bit Diameter: 251 mm

Product Weight: 143 lbs/ 65 kg

### OPERATING SUGGESTIONS

Weight on Bit: 20.0T / 44,093 lbs MAX

Rotational Speed: 60–100 rpm

Air Back Pressure: 29–58 psi/0.2–0.4 MPa



R feature



F feature

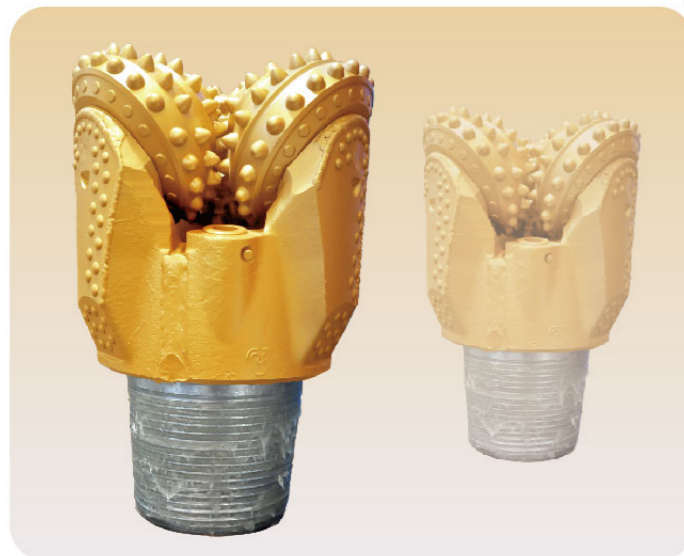

## 9 7/8 SGA715

### CUTTING STRUCTURE

Conical on gage, double spherical on inner rows.

Designed for high compressive strength, hard and abrasive formations, such as granite, limestone, sandy shale, dolomite, chert.

Compressive strength: 37,000–44,000 psi/255–303 MPa

### SHIRTTAIL PROTECTION

Hard welding and wear resistant carbide protection on shirrtail lip and lug.

### PRODUCT SPECIFICATION

IADC Code: 715

Bearing Type: Roller–Ball–Roller–Thrust/Sealed Bearing

Circulation Type: Jet Air

Cutting Structure:

Inner Rows: Double spherical

Gage Rows: Conical

Gage Bevel Protection: Flat

Pin Connection: 6 5/8" API REG

Metric Bit Diameter: 251 mm

Product Weight: 143 lbs/65 kg

### OPERATING SUGGESTIONS

Weight on Bit: 39,500–59,250 lbs/17.9–26.9 T

Rotational Speed: 60–90 rpm

Air Back Pressure: 29–58 psi/0.2–0.4 MPa

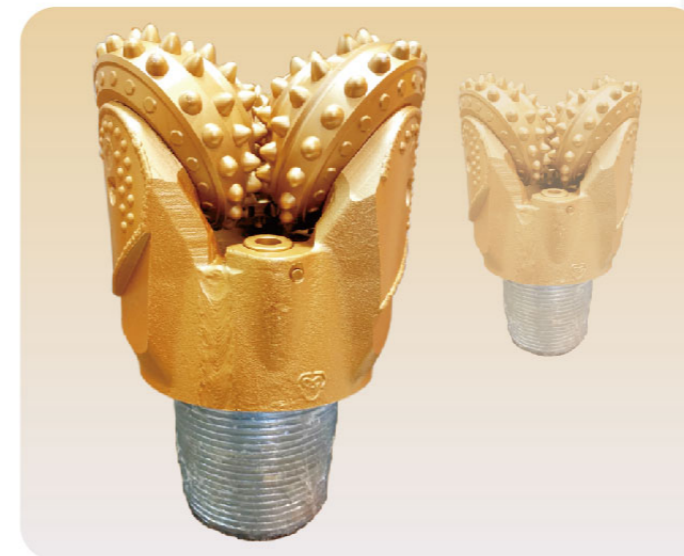

## 9 7/8 SGA745R

### CUTTING STRUCTURE

Spherical on gage, double spherical and conical on inner rows, with auxiliary carbide protection.

Designed for high compressive strength, hard and abrasive formations, such as granite, limestone, sandstone, dolomite.

Compressive strength: 43,000–52,000 psi/296–358 MPa

### SHIRTTAIL PROTECTION

Hard metal and wear resistant carbide on shirrtail lip and lug.

### PRODUCT SPECIFICATION

IADC Code: 745

Bearing Type: Roller–Ball–Roller–Thrust Button/Sealed Bearing

Circulation Type: Jet Air

Cutting Structure:

Inner and Nose Rows: Double spherical and conical

Gage Rows: Spherical

Gage Bevel Protection: Ovoid

Pin Connection: 6 5/8" API REG

Metric Bit Diameter: 251 mm

Product Weight: 143 lbs/ 65 kg

### OPERATING SUGGESTIONS

Weight on Bit: 20.0T / 44,093 lbs MAX

Rotational Speed: 90–60rpm

Air Back Pressure: 29–58 psi/0.2–0.4 MPa

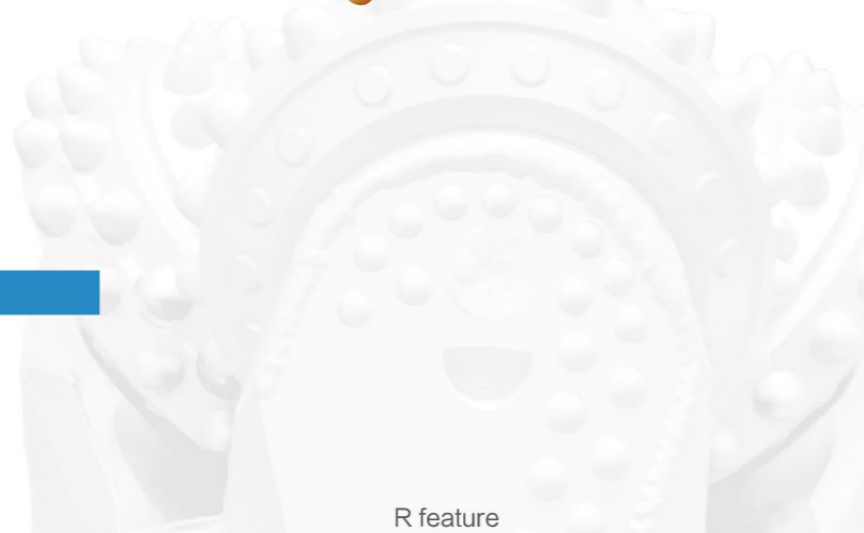

R feature

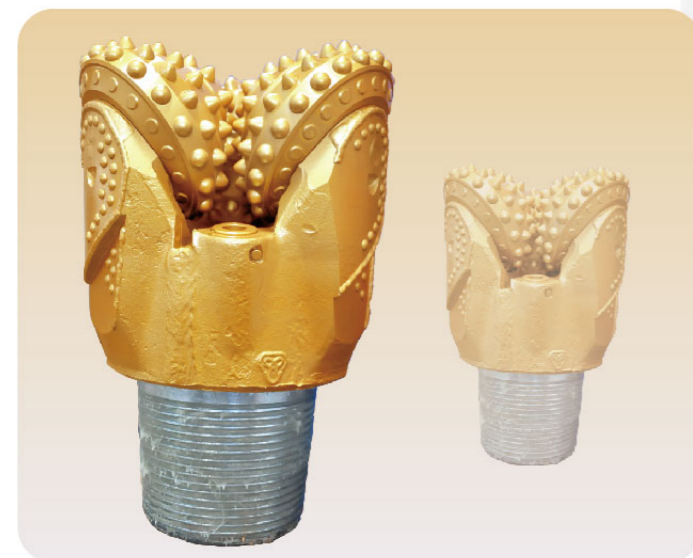

## 10 5/8 SGV415RS

### CUTTING STRUCTURE

Chisel on gage, spoon on inner rows.

Designed for extremely soft formation with low compressive strength and high drillability, such as shale, soft limestone, soft sandstone, gravelly clay, soft dolomite, salt rock, coal seam.

Compressive strength: 4,000–7,000 psi/27–48 MPa

### SHIRTTAIL PROTECTION

Hard welding and wear resistant carbide protection on shirrtail lip and lug.

### PRODUCT SPECIFICATION

IADC Code: 415

Bearing Type: Roller–Ball–Roller–Thrust/Sealed Bearing

Circulation Type: Jet Air

Cutting Structure:

Inner Rows: Spoon

Gage Rows: Chisel

Gage Bevel Protection: Ovoid

Pin Connection: 6 5/8" API REG

Metric Bit Diameter: 270 mm

Product Weight: 162 lbs/74 kg

### OPERATING SUGGESTIONS

Weight on Bit: 10,625–21,250 lbs/4.8–9.6 T

Rotational Speed: 90–120 rpm

Air Back Pressure: 29–58 psi/0.2–0.4 MPa



## 10 5/8 SGV425RS

### CUTTING STRUCTURE

Chisel on gage, conical on inner rows.

Designed for soft formation with low compressive strength and high drillability, such as shale, soft limestone, soft sandstone, gravelly clay, soft dolomite, salt rock, coal seam.

Compressive strength: 5,000–8,000 psi/34–55 MPa

### SHIRTTAIL PROTECTION

Hard welding and wear resistant carbide protection on shirrtail lip and lug

### PRODUCT SPECIFICATION

IADC Code: 425  
 Bearing Type: Roller–Ball–Roller–Thrust/Sealed Bearing  
 Circulation Type: Jet Air  
 Cutting Structure:  
 Inner Rows: Conical  
 Gage Rows: Chisel  
 Gage Bevel Protection: Ovoid  
 Pin Connection: 6 5/8" API REG  
 Metric Bit Diameter: 270 mm  
 Product Weight: 162 lbs/74 kg

### OPERATING SUGGESTIONS

Weight on Bit: 10,625–21,250 lbs/4.8–9.6 T  
 Rotational Speed: 90–120 rpm  
 Air Back Pressure: 29–58 psi/0.2–0.4 MPa

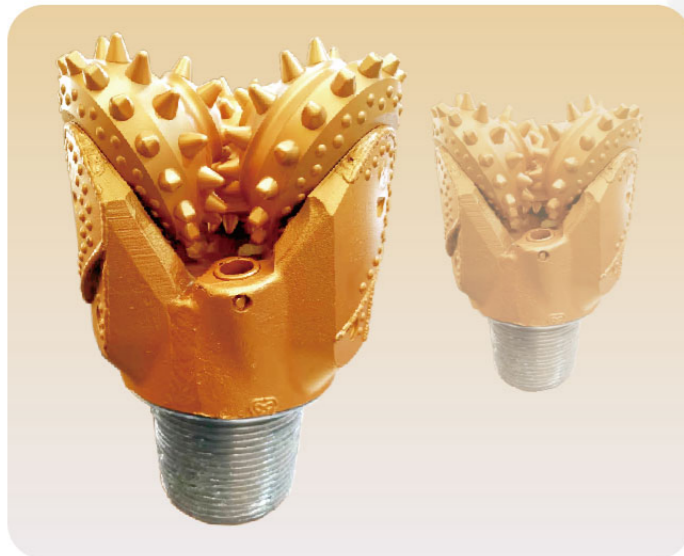

## 10 5/8 SGV515RS

### CUTTING STRUCTURE

Chisel on gage, conical on inner rows.

Designed for medium soft formation with low compressive strength, such as shale, soft limestone, conglomerate, interbedded dolomite, coal seam.

Compressive strength: 12,000–18,000 psi/83–124 MPa

### SHIRTTAIL PROTECTION

Hard welding and wear resistant carbide protection on shirrtail lip and lug

### PRODUCT SPECIFICATION

IADC Code: 515  
 Bearing Type: Roller–Ball–Roller–Thrust/Sealed Bearing  
 Circulation Type: Jet Air  
 Cutting Structure:  
 Inner Rows: Conical  
 Gage Rows: Chisel  
 Gage Bevel Protection: Ovoid  
 Pin Connection: 6 5/8" API REG  
 Metric Bit Diameter: 270 mm  
 Product Weight: 162 lbs/74 kg

### OPERATING SUGGESTIONS

Weight on Bit: 14,525–48420 lbs/6.6–22 T  
 Rotational Speed: 80–120 rpm  
 Air Back Pressure: 29–58 psi/0.2–0.4 MPa

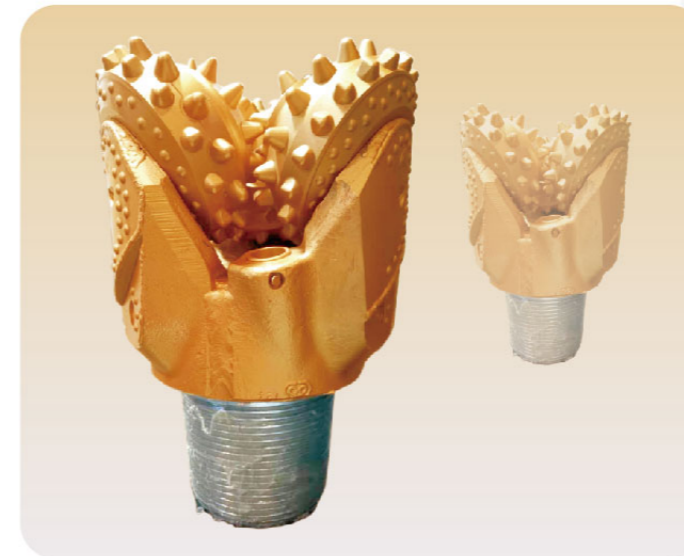

## 10 5/8 SGV635GF

### CUTTING STRUCTURE

Spherical on gage, double spherical on inner rows, with auxiliary carbide protection.

Designed for high compressive strength, medium hard and abrasive formations, such as limestone, sandstone, dolomite, chert.

Compressive strength: 29,000–38,000 psi/200–262 MPa

### SHIRTTAIL PROTECTION

Hard welding and wear resistant carbide protection on shirrtail lip and lug

### PRODUCT SPECIFICATION

IADC Code: 635  
 Bearing Type: Roller–Ball–Roller–Thrust/Sealed Bearing  
 Circulation Type: Jet Air  
 Cutting Structure:  
 Inner Rows: Double spherical  
 Gage Rows: Spherical  
 Auxiliary Carbide: Ovoid  
 Gage Bevel Protection: Ovoid  
 Pin Connection: 6 5/8" API REG  
 Metric Bit Diameter: 270 mm  
 Product Weight: 162 lbs/74 kg

### OPERATING SUGGESTIONS

Weight on Bit: 31,875–63,750 lbs/14.5–28.9 T  
 Rotational Speed: 60–100 rpm  
 Air Back Pressure: 29–58 psi/0.2–0.4 MPa

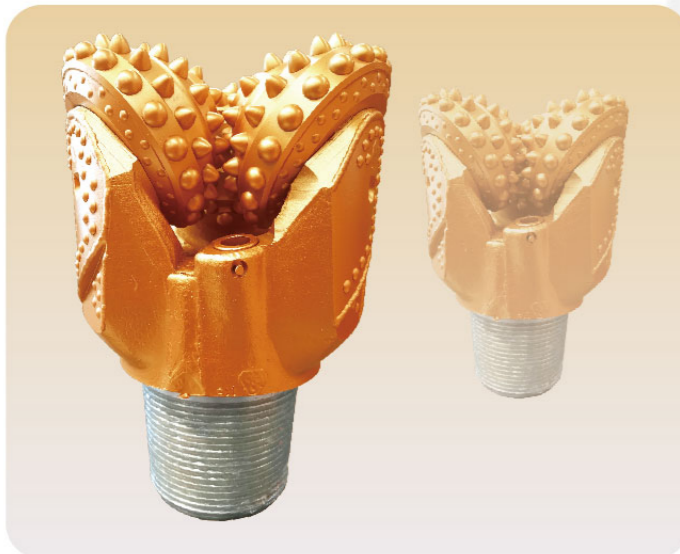
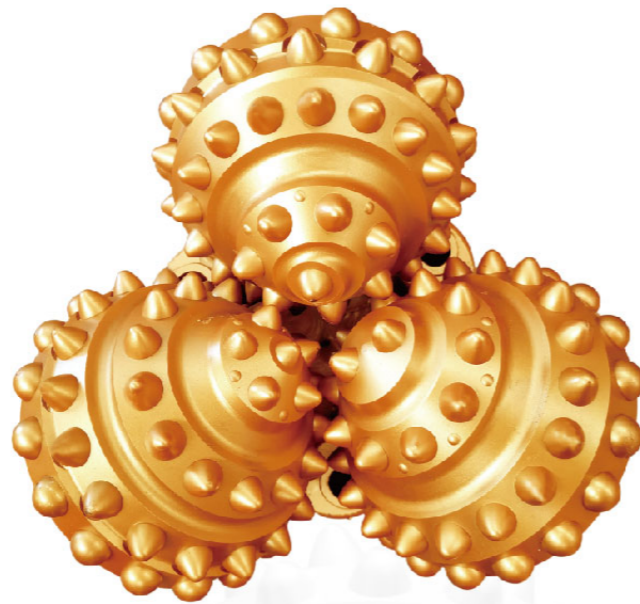

## 10 5/8 SGV645R

### CUTTING STRUCTURE

Conical on gage, double spherical on inner rows.

Designed for high compressive strength, medium hard and abrasive formations, such as limestone, sandstone, dolomite, chert.

Compressive strength: 32,000–42,000 psi/221–290 MPa

### SHIRTTAIL PROTECTION

Hard welding and wear resistant carbide protection on shirrtail lip and lug

### PRODUCT SPECIFICATION

IADC Code: 645  
 Bearing Type: Roller–Ball–Roller–Thrust/Sealed Bearing  
 Circulation Type: Jet Air  
 Cutting Structure:  
 Inner Rows: Double spherical  
 Gage Rows: Conical  
 Gage Bevel Protection: Ovoid  
 Pin Connection: 6 5/8" API REG  
 Metric Bit Diameter: 270 mm  
 Product Weight: 162 lbs/74 kg

### OPERATING SUGGESTIONS

Weight on Bit: 31,875–63,750 lbs/14.5–28.9 T  
 Rotational Speed: 60–100 rpm  
 Air Back Pressure: 29–58 psi/0.2–0.4 MPa

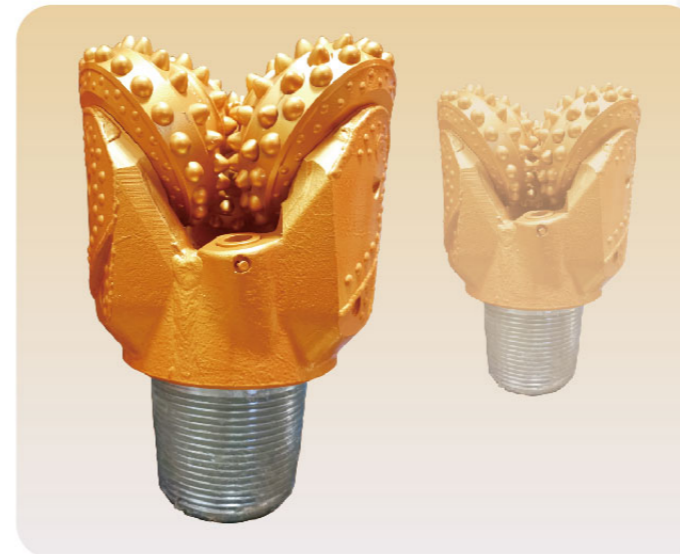



# 11 SGV645

## CUTTING STRUCTURE

Conical on gage, double spherical on inner rows.  
 Designed for high compressive strength, medium hard and abrasive formations, such as limestone, sandstone, interbedded dolomite.  
 Compressive strength: 32,000–42,000 psi/220–289 MPa

## SHIRTTAIL PROTECTION

Hard welding and wear resistant carbide protection on shirrtail lip and lug

## PRODUCT SPECIFICATION

IADC Code: 645  
 Bearing Type: Roller–Ball–Roller–Thrust Button/Sealed Bearing  
 Circulation Type: Jet Air  
 Cutting Structure:  
 Inner and Nose Rows: Double spherical  
 Gage Rows: Conical  
 Gage Bevel Protection: Ovoid  
 Pin Connection: 6 5/8" API REG  
 Metric Bit Diameter: 279mm  
 Product Weight: 167 lbs/76 kg

## OPERATING SUGGESTIONS

Weight on Bit: 33,000–66,000lb/15–30T  
 Rotational Speed: 60–100 rpm  
 Air Back Pressure: 29–58 psi/0.2–0.4 MPa

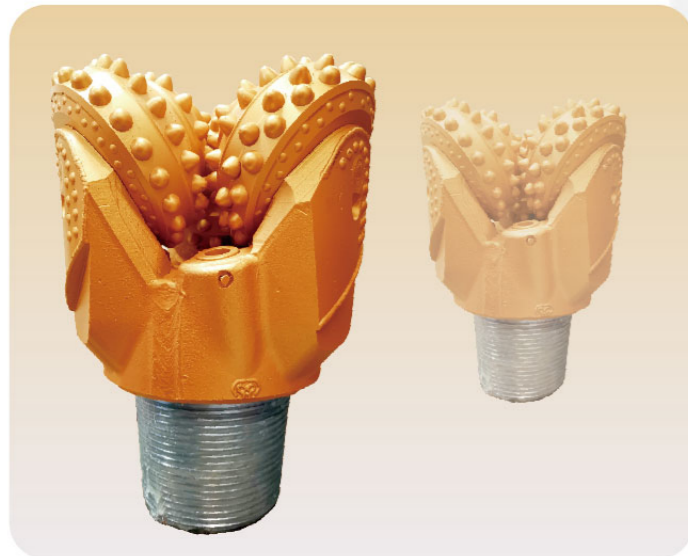
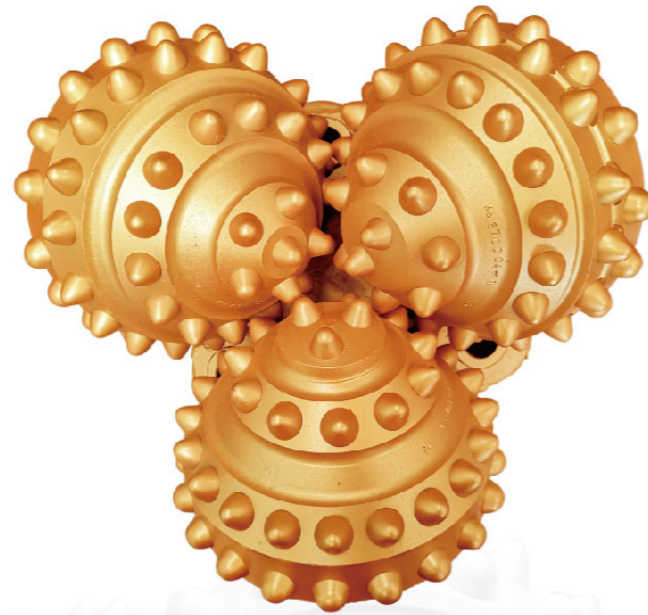

# 11 SGA745G

## CUTTING STRUCTURE

Conical on gage, double spherical on inner rows.  
 Designed for high compressive strength, hard and abrasive formations, such as granite, limestone, sandstone, dolomite.  
 Compressive strength: 46,000–56,000 psi/317–386 MPa

## SHIRTTAIL PROTECTION

Hard welding and wear resistant carbide protection on shirrtail lip and lug

## PRODUCT SPECIFICATION

IADC Code: 745  
 Bearing Type: Roller–Ball–Roller–Thrust Button/Sealed Bearing  
 Circulation Type: Jet Air  
 Cutting Structure:  
 Inner and Nose Rows: Double spherical  
 Gage Rows: Spherical  
 Auxiliary Carbide: Spherical  
 Pin Connection: 6 5/8" API REG  
 Metric Bit Diameter: 279mm  
 Product Weight: 167 lbs/76 kg

## OPERATING SUGGESTIONS

Weight on Bit: 44,000–77,000lb/20–35T  
 Rotational Speed: 60–90 rpm  
 Air Back Pressure: 29–58 psi/0.2–0.4 MPa

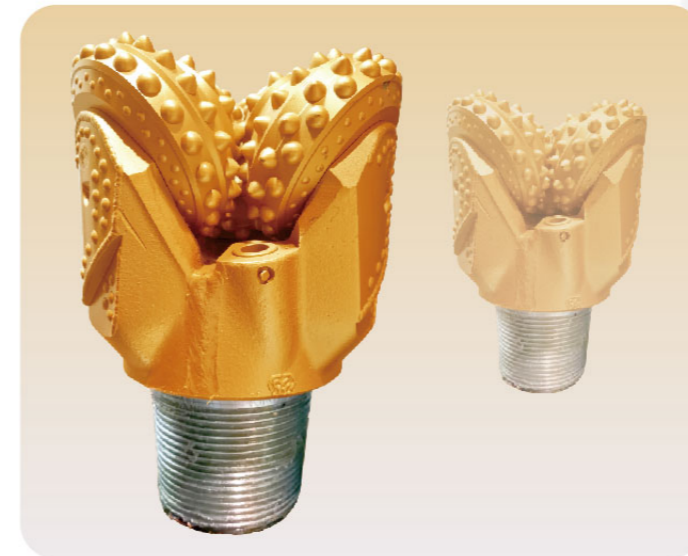
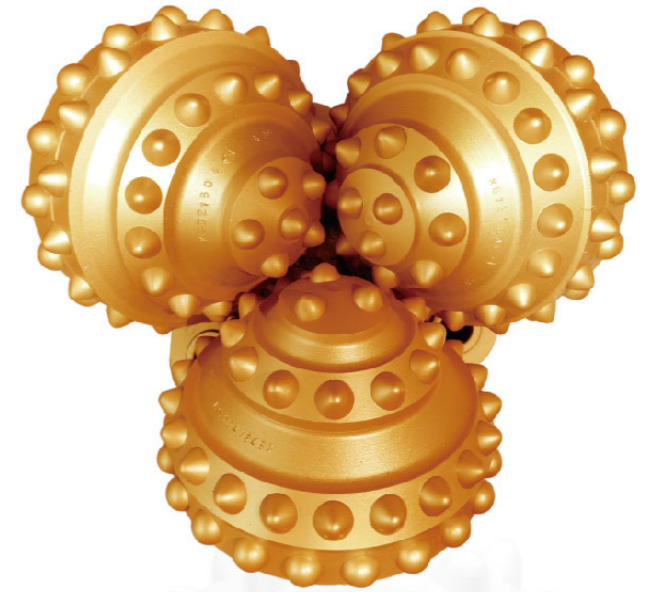

## 12 1/4 SGA545R

### CUTTING STRUCTURE

Spherical on gage, double spherical on inner rows.  
Designed for soft formations with low compressive strength, such as shale, soft limestone, interbedded dolomite, coal ore.  
Compressive strength: 18,000–27,000 psi/124–186 MPa

### SHIRTTAIL PROTECTION

Hard welding and wear resistant carbide protection on shirrtail lip and lug

### PRODUCT SPECIFICATION

IADC Code: 545  
Bearing Type: Roller–Ball–Roller–Thrust Button/Sealed Bearing  
Circulation Type: Jet Air  
Cutting Structure:  
Inner and Nose Rows: Double spherical  
Gage Rows: Spherical  
Auxiliary Carbide: Spherical  
Pin Connection: 6 5/8" API REG  
Metric Bit Diameter: 311mm  
Product Weight: 215 lbs/98 kg

### OPERATING SUGGESTIONS

Weight on Bit: 24,500–61,250lb/11.1–27.8T  
Rotational Speed: 80–110 rpm  
Air Back Pressure: 29–58 psi/0.2–0.4 MPa

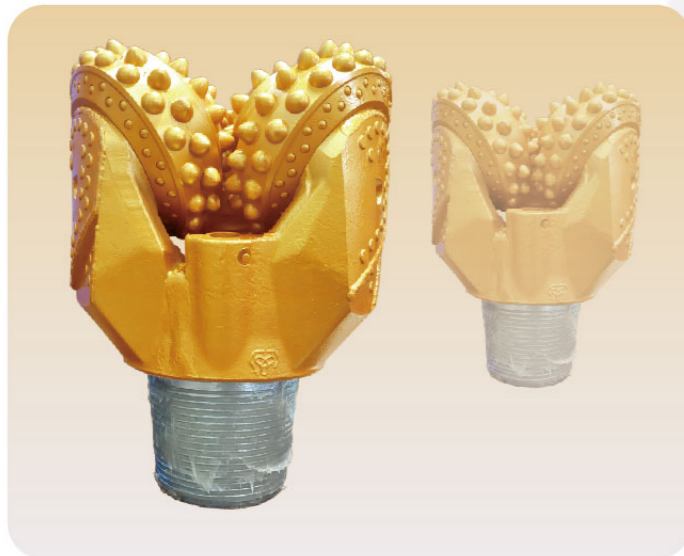

## 12 1/4 SGA625GS

### CUTTING STRUCTURE

Spherical on gage, double spherical on inner rows.  
Designed for high compressive strength, medium hard and abrasive formations, such as limestone, sandstone, interbedded dolomite.  
Compressive strength: 29,000–38,000 psi/200–262 MPa

### SHIRTTAIL PROTECTION

Hard welding and wear resistant carbide protection on shirrtail lip and lug

### PRODUCT SPECIFICATION

IADC Code: 625  
Bearing Type: Roller–Ball–Roller–Thrust Button/Sealed Bearing  
Circulation Type: Jet Air  
Cutting Structure:  
Inner and Nose Rows: Double spherical  
Gage Rows: Spherical  
Auxiliary Carbide: Flat  
Pin Connection: 6 BECO  
Metric Bit Diameter: 311mm  
Product Weight: 215 lbs/98 kg

### OPERATING SUGGESTIONS

Weight on Bit: 33,000–66,000lb/15–30T  
Rotational Speed: 60–100 rpm  
Air Back Pressure: 29–58 psi/0.2–0.4 MPa

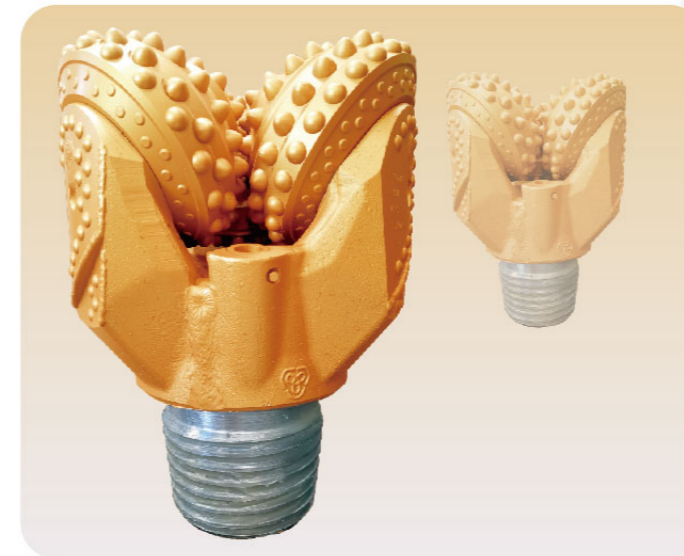

## 12 1/4 SGA635R

### CUTTING STRUCTURE

Spherical on gage, double spherical on inner rows.  
Designed for high compressive strength, medium hard and abrasive formations, such as limestone, sandstone, interbedded dolomite.  
Compressive strength: 29,000–38,000 psi/200–262 MPa

### SHIRTTAIL PROTECTION

Hard welding and wear resistant carbide protection on shirrtail lip and lug

### PRODUCT SPECIFICATION

IADC Code: 635  
Bearing Type: Roller–Ball–Roller–Thrust Button/Sealed Bearing  
Circulation Type: Jet Air  
Cutting Structure:  
Inner and Nose Rows: Double spherical  
Gage Rows: Spherical  
Auxiliary Carbide: Spherical  
Pin Connection: 6 5/8" API REG  
Metric Bit Diameter: 311mm  
Product Weight: 215 lbs/98 kg

### OPERATING SUGGESTIONS

Weight on Bit: 36,750–73,500lb/16.7–33.3T  
Rotational Speed: 60–100 rpm  
Air Back Pressure: 29–58 psi/0.2–0.4 MPa

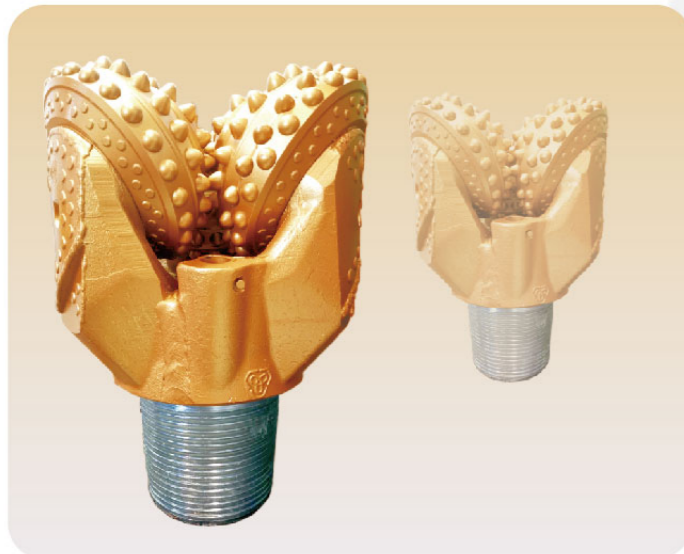

## 12 1/4 SGA645G

### CUTTING STRUCTURE

Spherical on gage, double spherical on inner rows.  
Designed for high compressive strength, medium hard and abrasive formations, such as limestone, sandstone, interbedded dolomite.  
Compressive strength: 29,000–38,000 psi/200–262 MPa

### SHIRTTAIL PROTECTION

Hard welding and wear resistant carbide protection on shirrtail lip and lug

### PRODUCT SPECIFICATION

IADC Code: 645  
Bearing Type: Roller–Ball–Roller–Thrust Button/Sealed Bearing  
Circulation Type: Jet Air  
Cutting Structure:  
Inner and Nose Rows: Double spherical  
Gage Rows: Spherical  
Auxiliary Carbide: Spherical  
Pin Connection: 6 5/8" API REG  
Metric Bit Diameter: 311mm  
Product Weight: 215 lbs/98 kg

### OPERATING SUGGESTIONS

Weight on Bit: 36,750–73,500lb/16.7–33.3T  
Rotational Speed: 60–100 rpm  
Air Back Pressure: 29–58 psi/0.2–0.4 MPa

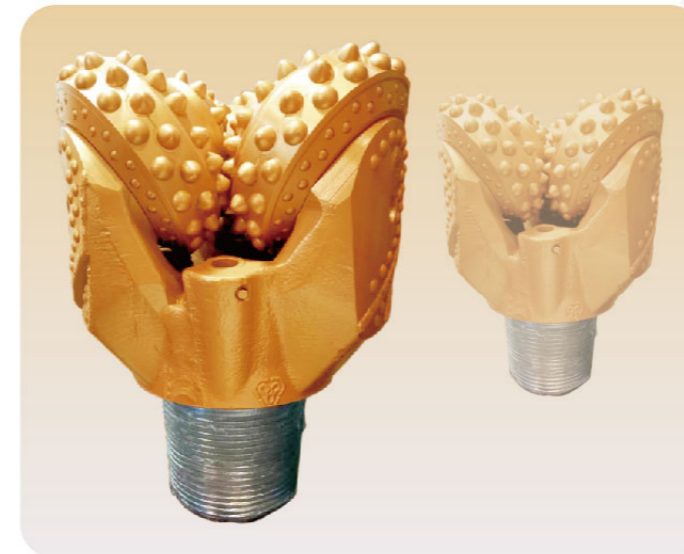

## 12 1/4 SGA715G

### CUTTING STRUCTURE

Spherical on gage, double spherical on inner rows.  
Designed for high compressive strength, hard and abrasive formations, such as granite, limestone, sandstone, dolomite.  
Compressive strength: 37,000–44,000 psi/255–303 MPa

### SHIRTTAIL PROTECTION

Hard welding and wear resistant carbide protection on shirrtail lip and lug

### PRODUCT SPECIFICATION

IADC Code: 715  
Bearing Type: Roller–Ball–Roller–Thrust Button/Sealed Bearing  
Circulation Type: Jet Air  
Cutting Structure:  
Inner and Nose Rows: Double spherical  
Gage Rows: Spherical  
Auxiliary Carbide: Flat  
Pin Connection: 6 5/8" API REG  
Metric Bit Diameter: 311mm  
Product Weight: 215 lbs/98 kg

### OPERATING SUGGESTIONS

Weight on Bit: 49,000–73,500lb/22.2–33.3T  
Rotational Speed: 60–90 rpm  
Air Back Pressure: 29–58 psi/0.2–0.4 MPa



## 12 1/4 SGA715R

### CUTTING STRUCTURE

Spherical on gage, double spherical on inner rows.  
Designed for high compressive strength, hard and abrasive formations, such as granite, limestone, sandstone, dolomite.  
Compressive strength: 37,000–44,000 psi/255–303 MPa

### SHIRTTAIL PROTECTION

Hard welding and wear resistant carbide protection on shirrtail lip and lug

### PRODUCT SPECIFICATION

IADC Code: 715  
Bearing Type: Roller–Ball–Roller–Thrust Button/Sealed Bearing  
Circulation Type: Jet Air  
Cutting Structure:  
Inner and Nose Rows: Double spherical  
Gage Rows: Spherical  
Auxiliary Carbide: Flat  
Pin Connection: 6 5/8" API REG  
Metric Bit Diameter: 311mm  
Product Weight: 215 lbs/98 kg

### OPERATING SUGGESTIONS

Weight on Bit: 49,000–73,500lb/22.2–33.3T  
Rotational Speed: 60–90 rpm  
Air Back Pressure: 29–58 psi/0.2–0.4 MPa

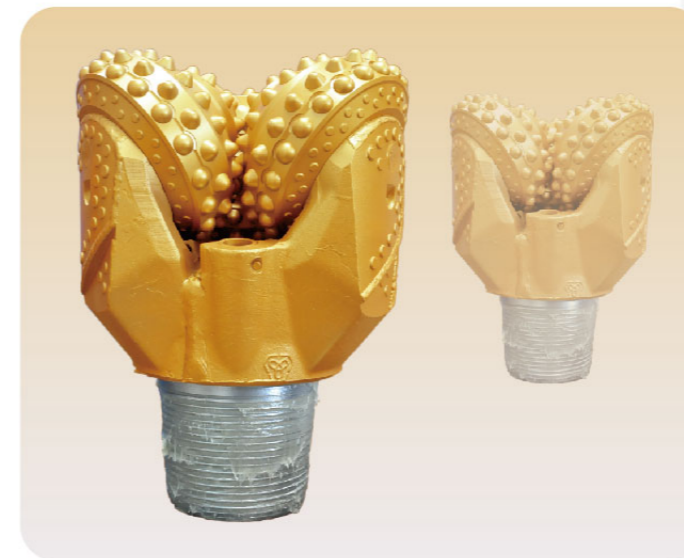

## 12 1/4 SGA725GF

### CUTTING STRUCTURE

Spherical on gage, double spherical on inner rows, with auxiliary carbide protection.

Designed for high compressive strength, hard and abrasive formations, such as granite, limestone, sandstone, dolomite.

Compressive strength: 40,000–48,000 psi/275–331 MPa

### SHIRTTAIL PROTECTION

Hard welding and wear resistant carbide protection on shirrtail lip and lug

### PRODUCT SPECIFICATION

IADC Code: 725

Bearing Type: Roller–Ball–Roller–Thrust Button/Sealed Bearing

Circulation Type: Jet Air

Cutting Structure:

Inner and Nose Rows: Double spherical

Gage Rows: Spherical

Auxiliary Carbide: Spherical

Gage Bevel Protection: Flat

Pin Connection: 6 BECO

Metric Bit Diameter: 311mm

Product Weight: 215 lbs/98 kg

### OPERATING SUGGESTIONS

Weight on Bit: 49,000–73,500lb/22.2–33.3T

Rotational Speed: 60–90 rpm

Air Back Pressure: 29–58 psi/0.2–0.4 MPa

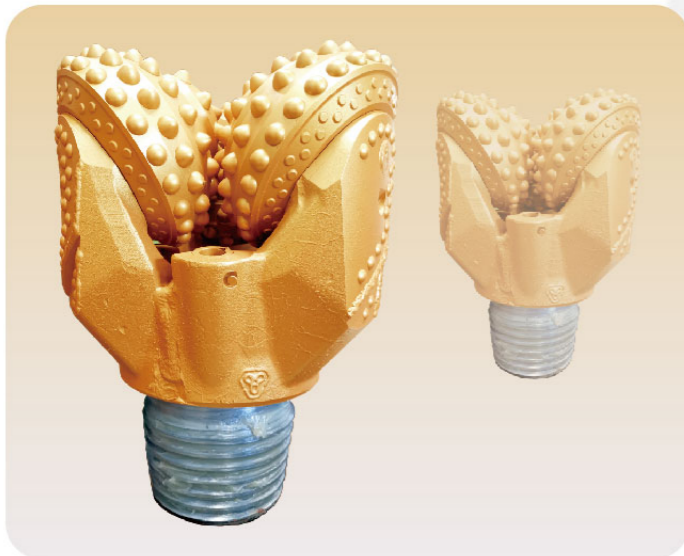

## 12 1/4 SGA735R

### CUTTING STRUCTURE

Spherical on gage, double spherical on inner rows.

Designed for high compressive strength, hard and abrasive formations, such as granite, limestone, sandstone, dolomite.

Compressive strength: 43,000–52,000 psi/296–358 MPa

### SHIRTTAIL PROTECTION

Hard welding and wear resistant carbide protection on shirrtail lip and lug

### PRODUCT SPECIFICATION

IADC Code: 735

Bearing Type: Roller–Ball–Roller–Thrust Button/Sealed Bearing

Circulation Type: Jet Air

Cutting Structure:

Inner and Nose Rows: Double spherical

Gage Rows: Spherical

Auxiliary Carbide: Flat

Pin Connection: 6 5/8" API REG

Metric Bit Diameter: 311mm

Product Weight: 215 lbs/98 kg

### OPERATING SUGGESTIONS

Weight on Bit: 49,000–85,750lb/22.2–38.9T

Rotational Speed: 60–90 rpm

Air Back Pressure: 29–58 psi/0.2–0.4 MPa

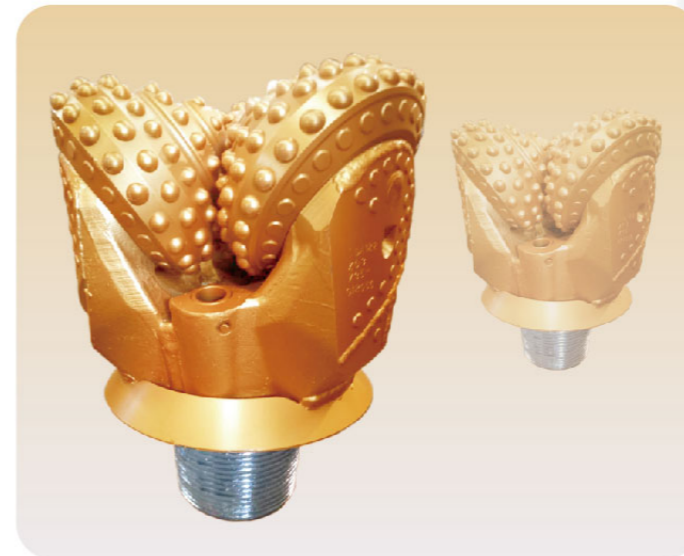

## 12 1/4 SGA745R

### CUTTING STRUCTURE

Spherical on gage, double spherical on inner rows.  
Designed for high compressive strength, hard and abrasive formations, such as granite, limestone, sandstone, dolomite.  
Compressive strength: 46,000–56,000 psi/317–386 MPa

### SHIRTTAIL PROTECTION

Hard welding and wear resistant carbide protection on shirrtail lip and lug

### PRODUCT SPECIFICATION

IADC Code: 745  
Bearing Type: Roller–Ball–Roller–Thrust Button/Sealed Bearing  
Circulation Type: Jet Air  
Cutting Structure:  
Inner and Nose Rows: Double spherical  
Gage Rows: Spherical  
Auxiliary Carbide: Spherical  
Pin Connection: 6 5/8" API REG  
Metric Bit Diameter: 311mm  
Product Weight: 215 lbs/98 kg

### OPERATING SUGGESTIONS

Weight on Bit: 49,000–85,750lb/22.2–38.9T  
Rotational Speed: 60–90 rpm  
Air Back Pressure: 29–58 psi/0.2–0.4 MPa

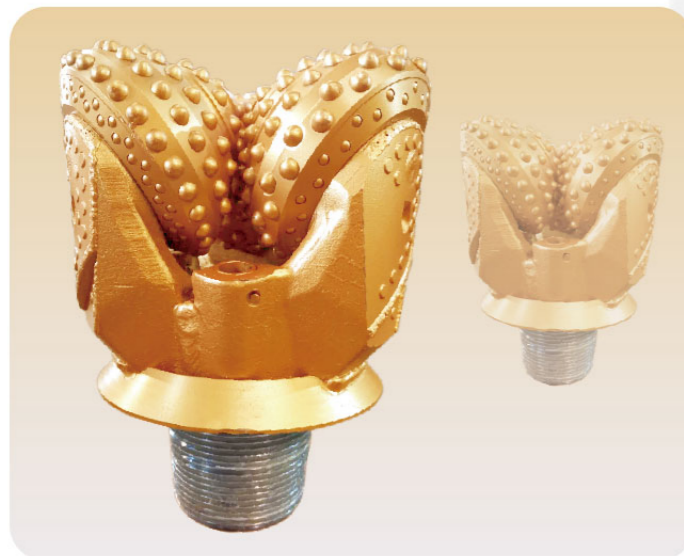

## 12 1/4 SGA835R

### CUTTING STRUCTURE

Spherical on gage and inner rows.  
Designed for high compressive strength, hard and abrasive formations, such as magnetite quartzite, quartzite, granite.  
Compressive strength: 55,000–66,000 psi/379–455 MPa

### SHIRTTAIL PROTECTION

Hard metal and wear resistant carbide on shirrtail lip and lug.

### PRODUCT SPECIFICATION

IADC Code: 835  
Bearing Type: Roller–Ball–Roller–Thrust Button/Sealed Bearing  
Circulation Type: Jet Air  
Cutting Structure:  
Inner and Nose Rows: Spherical  
Gage Rows: Spherical  
Gage Bevel Protection: Ovoid  
Pin Connection: 6 5/8" API REG  
Metric Bit Diameter: 311 mm  
Product Weight: 215 lbs/98 kg

### OPERATING SUGGESTIONS

Weight on Bit: 27.3T / 60,186 lbs MAX  
Rotational Speed: 50–80 rpm  
Air Back Pressure: 29–58 psi/0.2–0.4 MPa

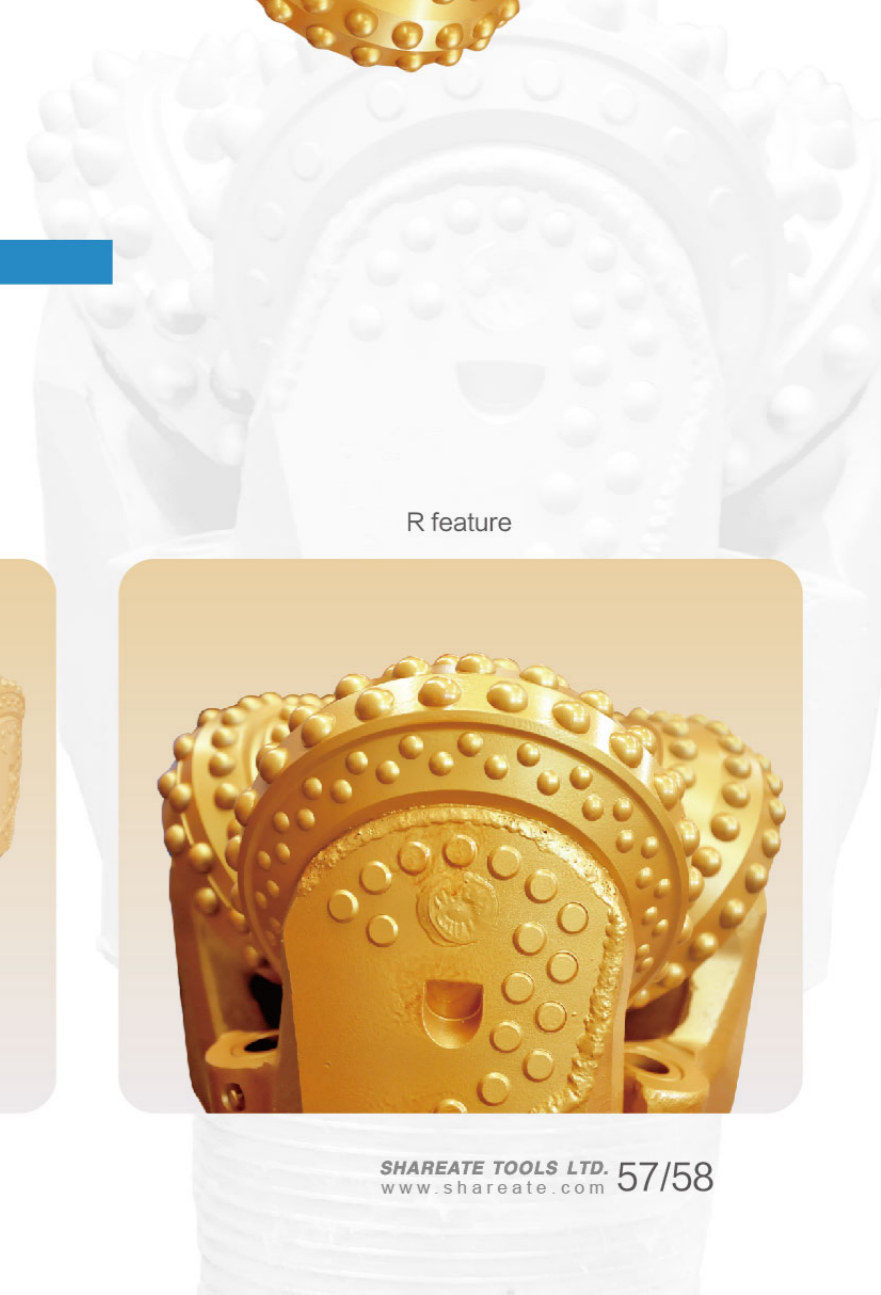

R feature

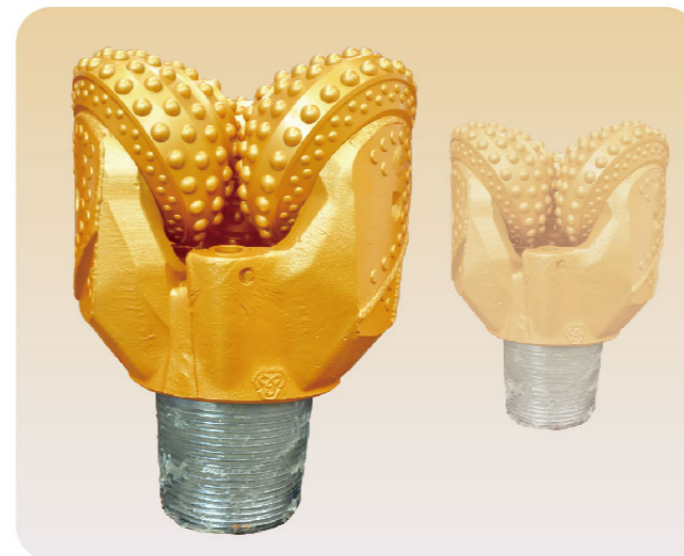

## 12 1/4 SGV745G

### CUTTING STRUCTURE

Spherical on gage, double spherical on inner rows.  
Designed for high compressive strength, hard and abrasive formations, such as granite, limestone, sandstone, dolomite.  
Compressive strength: 46,000–56,000 psi/317–386 MPa

### SHIRTTAIL PROTECTION

Hard welding and wear resistant carbide protection on shirrtail lip and lug

### PRODUCT SPECIFICATION

IADC Code: 745  
Bearing Type: Roller–Ball–Roller–Thrust Button/Sealed Bearing  
Circulation Type: Jet Air  
Cutting Structure:  
Inner and Nose Rows: Double spherical  
Gage Rows: Spherical  
Auxiliary Carbide: Spherical  
Pin Connection: 6 5/8" API REG  
Metric Bit Diameter: 311mm  
Product Weight: 215 lbs/98 kg

### OPERATING SUGGESTIONS

Weight on Bit: 49,000–85,750lb/22.2–38.9T  
Rotational Speed: 60–90 rpm  
Air Back Pressure: 29–58 psi/0.2–0.4 MPa



## 12 1/4 SGV745

### CUTTING STRUCTURE

Spherical on gage, double spherical on inner rows.  
Designed for high compressive strength, hard and abrasive formations, such as granite, limestone, sandstone, dolomite.  
Compressive strength: 46,000–56,000 psi/317–386 MPa

### SHIRTTAIL PROTECTION

Hard metal and wear resistant carbide on shirrtail lip and lug.

### PRODUCT SPECIFICATION

IADC Code: 745  
Bearing Type: Roller–Ball–Roller–Thrust Button/Sealed Bearing  
Circulation Type: Jet Air  
Cutting Structure:  
Inner and Nose Rows: Double spherical  
Gage Rows: Spherical  
Gage Bevel Protection: Ovoid  
Pin Connection: 6 5/8" API REG  
Metric Bit Diameter: 311 mm  
Product Weight: 215 lbs/98 kg

### OPERATING SUGGESTIONS

Weight on Bit: 27.3T / 60,186 lbs MAX  
Rotational Speed: 60–90 rpm  
Air Back Pressure: 29–58 psi/0.2–0.4 MPa

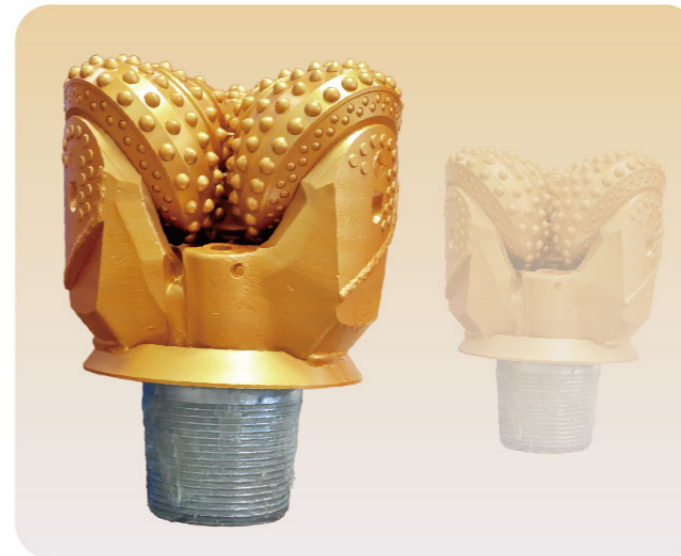

# 13 3/4 SGA635RF

## CUTTING STRUCTURE

Spherical on gage, double spherical on inner rows.  
 Designed for high compressive strength, medium hard and abrasive formations, such as limestone, sandstone, interbedded dolomite.  
 Compressive strength: 29,000–38,000 psi/200–262 MPa

## SHIRTTAIL PROTECTION

Hard welding and wear resistant carbide protection on shirrtail lip and lug

## PRODUCT SPECIFICATION

IADC Code: 635  
 Bearing Type: Roller–Ball–Roller–Thrust Button/Sealed Bearing  
 Circulation Type: Jet Air  
 Cutting Structure:  
 Inner and Nose Rows: Double spherical  
 Gage Rows: Spherical  
 Auxiliary Carbide: Spherical  
 Pin Connection: 6 5/8" API REG  
 Metric Bit Diameter: 349mm  
 Product Weight: 270 lbs/123 kg

## OPERATING SUGGESTIONS

Weight on Bit: 41,250–82,500lb/18.7–37.4T  
 Rotational Speed: 60–100 rpm  
 Air Back Pressure: 29–58 psi/0.2–0.4 MPa

